

# PRODUCT CATALOGUE



**SKLÁRNY  
MORAVIA**

**GLASS** that **WORKS**  
SINCE 1827





**GLASS** that **WORKS**  
SINCE 1827



# CONTENTS

---

<b>OUR COMPANY</b> .....	<b>7</b>
<b>VOLUME 40-249 ml</b> .....	<b>13</b>
<b>VOLUME 250-499 ml</b> .....	<b>29</b>
<b>VOLUME 500-699 ml</b> .....	<b>39</b>
<b>VOLUME 700-999 ml</b> .....	<b>69</b>
<b>VOLUME 1000+ ml</b> .....	<b>101</b>
<b>APOTHECARY JARS</b> .....	<b>111</b>



# OUR COMPANY

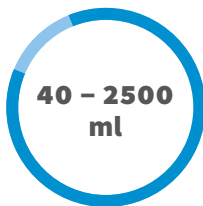
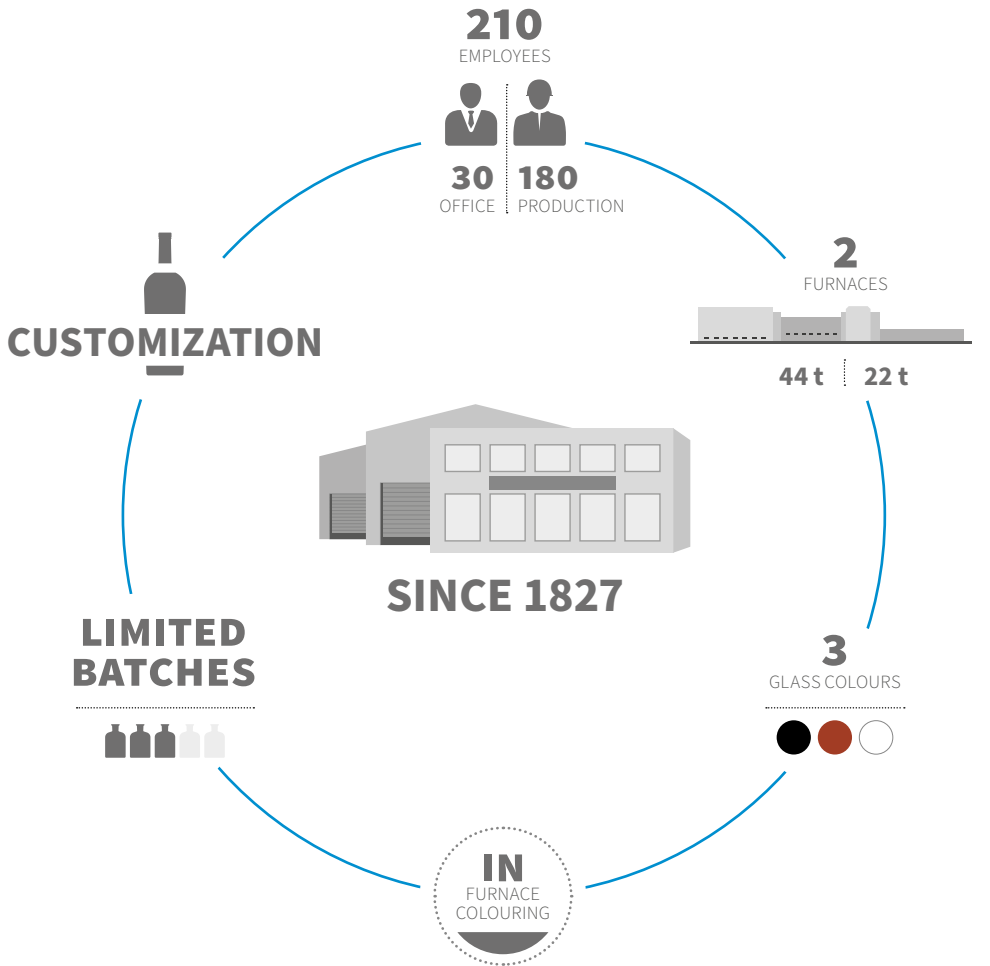

VOLUME

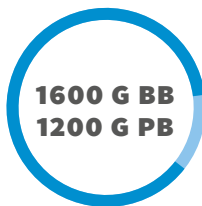

MAX. WEIGHT



STANDARD SERIES



DAILY CAPACITY  
OF EACH LINE

# PRODUCT DIMENSIONS

---

---

## BOTTLES / BLOW-BLOW

---

**MIN. HEIGHT UNDER FINISH**

38 mm

55 mm

**MAX. HEIGHT UNDER FINISH**

350 mm

300 mm

**MAX. BODY DIAMETER**

160 mm

76 mm

**MIN. BODY DIAMETER**

29 mm

29 mm

**MAX. FINISH DIAMETER**

56 mm

48 mm

**SINGLE GOB**

**DOUBLE GOB**





**SINGLE GOB**

**DOUBLE GOB**

40 mm	.....	45 mm	<b>MIN. HEIGHT UNDER FINISH</b>
270 mm	.....	282 mm	<b>MAX. HEIGHT UNDER FINISH</b>
160 mm	.....	76 mm	<b>MAX. BODY DIAMETER</b>
32 mm	.....	32 mm	<b>MIN. FINISH INNER BORE DIAMETER*</b>
120 mm	.....	83 mm	<b>MAX. FINISH DIAMETER</b>
1600 g	.....	1600 g	<b>MAX. WEIGHT</b>



\*Minimum finish inner diameter at the entrance.  
All values are indicative only. Each parameter affects others.

# CUSTOMIZATION

## FINISH TYPE

Each bottle can be provided with various finish options. Available types are listed in product sheets, but others can be provided on demand.

**Types:** cork, vinolok, GPI, GUALA, TO, PP, MCA and others



## BODY

- Full or partial body embossing and creation of private design from a standard shape – one of our semi-finished products on stock.
- Possibility of production of 0.7 and 0.75 l bottles from common blank mould (only blow moulds required).
- We offer direct production in short series with a whole set of moulds, production with common blank moulds and shared blow moulds or shared manufacturing with similar item in combination.  
Share ratios 5:1, 4:2 or 3:3. For 0.5 l bottle that is approximately 25:5k, 20:10k, or 15:15k bottles per day.



## BOTTOM

In some cases there is an option to alter the bottom of the bottle. Both punt and ice bottom will affect the bottle design and volume.



Screw

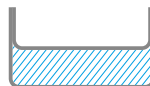

Ice bottom

 Bayonete

 Bartop

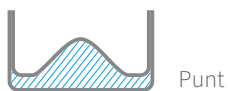

# HOT END FACILITY

## STANDARD HOT-END SETUP

10 blank moulds  
9 blow moulds

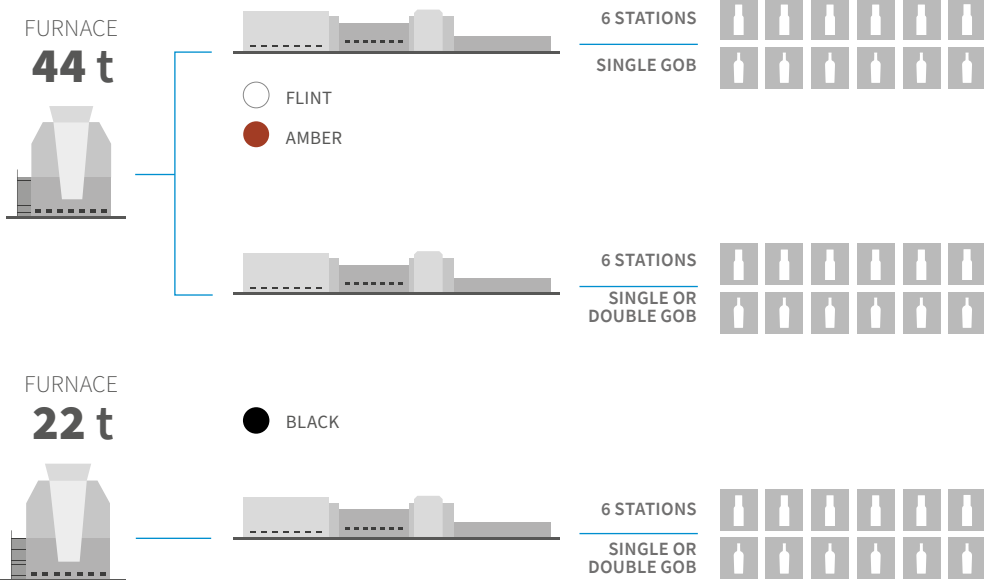

### COMBINATION 5:1



5 stations = 9 blank + 8 blow  
1 station = 3 blank + 2 blow

### COMBINATION 4:2



4 stations = 8 blank + 7 blow  
2 stations = 4 blank + 3 blow

### COMBINATION 3:3



3 stations = 6 blow + 4 blank

## Other production conditions in parallel

- For all square or otherwise shape-demanding bottles, it is necessary to count with one additional blow mould.
- As close as possible shape similarity (typically the same bottles with different embosses) is recommended.
- Weight difference max +/- 15 %
- Each parallel production must be assessed individually.

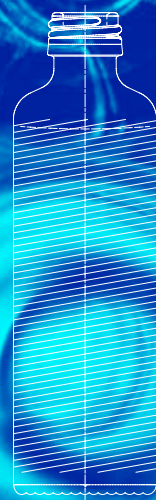



**VOLUME** 40 – 249 ml

---

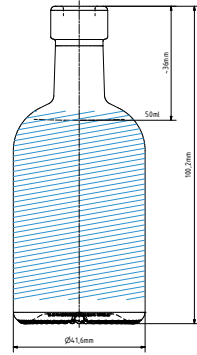

# B-LUX 0.05 L | 50 ml



 Area for personalization

## SPECIFICATION

Volume	<b>50 ml</b>
Brimful	<b>55 ml</b>
Weight	<b>95 g</b>
Height	<b>100.2 mm</b>
Diameter of body (max)	<b>41.6 mm</b>

## AVERAGE % OF RECYCLED CONTENT

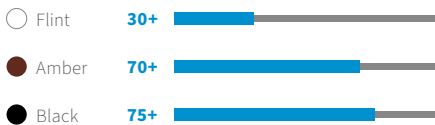

## FINISH TYPE

Bartop	Screw	Bayonete
		
<b>Cork 10</b>	<b>PP 18 S</b>	—
—	—	—
—	—	—
—	—	—

# LAB GIN 2000 0.05 L | 50 ml

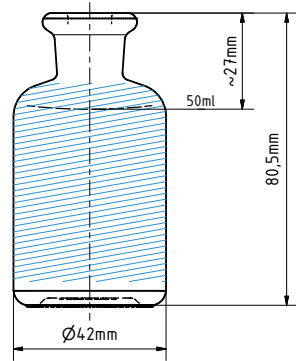

 Area for personalization



## SPECIFICATION

Volume	<b>50 ml</b>
Brimful	<b>54 ml</b>
Weight	<b>75 g</b>
Height	<b>80.5 mm</b>
Diameter of body	<b>42 mm</b>

## AVERAGE % OF RECYCLED CONTENT

○ Flint	<b>30+</b>	
● Amber	<b>70+</b>	
● Black	<b>75+</b>	

## FINISH TYPE

Bartop	Screw	Bayonete
		
<b>Cork 12</b>	<b>GPI 400M/18</b>	—
—	—	—
—	—	—
—	—	—



# MARTOFF 0.05 L | 50 ml

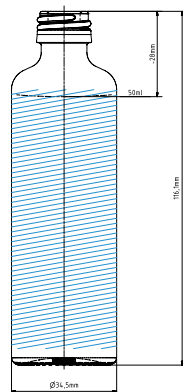

 Area for personalization



## SPECIFICATION

Volume	<b>50 ml</b>
Brimful	<b>58 ml</b>
Weight	<b>90 g</b>
Height	<b>116.1 mm</b>
Diameter of body (max)	<b>34.5 mm</b>

## AVERAGE % OF RECYCLED CONTENT



## FINISH TYPE

Bartop	Screw	Bayonete
		
—	<b>PP 18 S</b>	—
—	—	—
—	—	—
—	—	—

# B-LUX 0.1 L | 100 ml

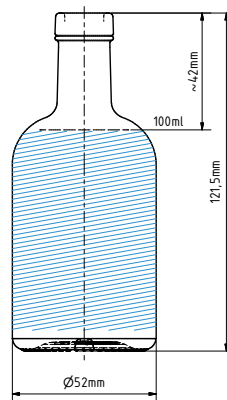



 Area for personalization



## SPECIFICATION

Volume	<b>100 ml</b>
Brimful	<b>108 ml</b>
Weight	<b>170 g</b>
Height	<b>121.5 mm</b>
Diameter of body (max)	<b>52 mm</b>

## AVERAGE % OF RECYCLED CONTENT

○ Flint	<b>30+</b>	
● Amber	<b>70+</b>	
● Black	<b>75+</b>	

## FINISH TYPE

Bartop	Screw	Bayonete
		
<b>Cork 14</b>	<b>GPI 400/20</b>	—
—	<b>PP 22</b>	—
—	—	—
—	—	—

# CREAM LIQUER 0.1 L | 100 ml

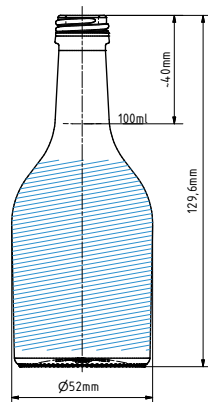

 Area for personalization



## SPECIFICATION

Volume	<b>100 ml</b>
Brimful	<b>108 ml</b>
Weight	<b>130 g</b>
Height	<b>129.6 mm</b>
Diameter of body (max)	<b>52 mm</b>

## AVERAGE % OF RECYCLED CONTENT



## FINISH TYPE

Bartop	Screw	Bayonete
		
—	<b>PP 20 S</b>	—
—	—	—
—	—	—
—	—	—

# VODKA BOTTLE 0.1 L | 100 ml

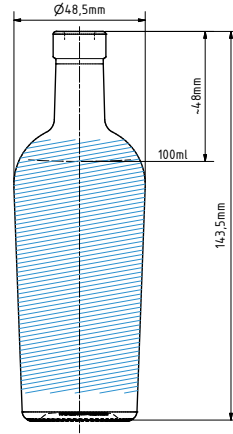



 Area for personalization



## SPECIFICATION

Volume	<b>100 ml</b>
Brimful	<b>110 ml</b>
Weight	<b>170 g</b>
Height	<b>143.5 mm</b>
Diameter of body (max)	<b>48.5 mm</b>

## AVERAGE % OF RECYCLED CONTENT

 Flint	<b>30+</b>	
 Amber	<b>70+</b>	
 Black	<b>75+</b>	

## FINISH TYPE

Bartop	Screw	Bayonete
		
<b>Cork 11</b>	<b>GPI 400/20</b>	—
—	—	—
—	—	—
—	—	—

# MEPLAT 0.15 L | 150 ml

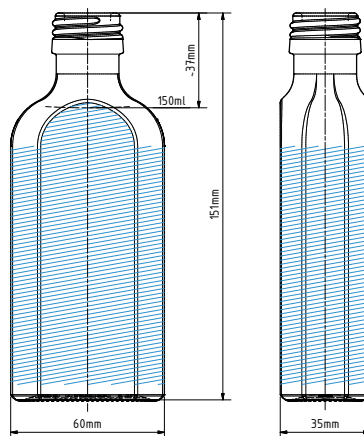

 Area for personalization



## SPECIFICATION

Volume	<b>150 ml</b>
Brimful	<b>165 ml</b>
Weight	<b>180 g</b>
Height	<b>151 mm</b>
Diameter of body (max)	<b>60 × 35 mm</b>

## AVERAGE % OF RECYCLED CONTENT



## FINISH TYPE

Bartop	Screw	Bayonete
		
—	<b>PP 28 × 22</b>	—
—	<b>B 22</b>	—
—	—	—
—	—	—

# B-LUX 0.2 L | 200 ml

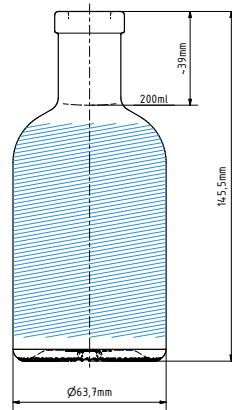



 Area for personalization



## SPECIFICATION

Volume	<b>200 ml</b>
Brimful	<b>212 ml</b>
Weight	<b>300 g</b>
Height	<b>145.5 mm</b>
Diameter of body (max)	<b>63.7 mm</b>

## AVERAGE % OF RECYCLED CONTENT

○ Flint	<b>30+</b>	
● Amber	<b>70+</b>	
● Black	<b>75+</b>	

## FINISH TYPE

Bartop	Screw	Bayonete
		
<b>Cork 17.5</b>	<b>GPI 400/28</b>	—
<b>Vinlok 17.5</b>	<b>PP 28</b>	—
<b>Vinlok 18.5</b>	—	—
—	—	—

# BLESKA 0.2 L | 200 ml

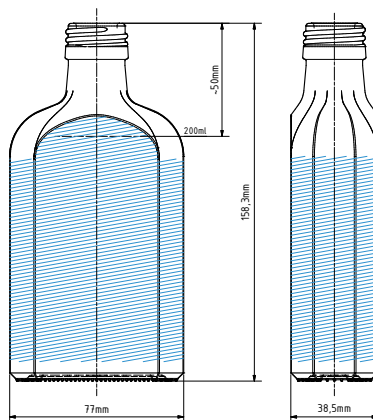

 Area for personalization



## SPECIFICATION

Volume	<b>200 ml</b>
Brimful	<b>230 ml</b>
Weight	<b>245 g</b>
Height	<b>158.3 mm</b>
Dimensions of body (max)	<b>77 × 38.5 mm</b>

## AVERAGE % OF RECYCLED CONTENT



## FINISH TYPE

Bartop	Screw	Bayonete
		
—	<b>PP 28</b>	—
—	<b>MCA 2</b>	—
—	—	—
—	—	—

# EXCLUSIVE 0.2 L | 200 ML

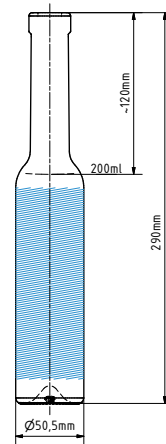

 Area for personalization



## SPECIFICATION

Volume	<b>200 ml</b>
Brimful	<b>235 ml</b>
Weight	<b>450 g</b>
Height	<b>290 mm</b>
Diameter of body (max)	<b>50.5 mm</b>

## AVERAGE % OF RECYCLED CONTENT

○ Flint	<b>30+</b>	
● Amber	<b>70+</b>	
● Black	<b>75+</b>	

## FINISH TYPE

Bartop	Screw	Bayonete
		
<b>Cork 17.5</b>	<b>CET 31.5</b>	—
<b>Cork 18.5</b>	—	—
<b>Vinlok 18.5</b>	—	—
—	—	—



# GRAPES 0.2 L | 200 ml

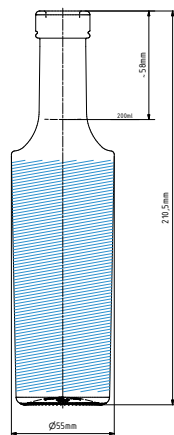

 Area for personalization



## SPECIFICATION

Volume	<b>200 ml</b>
Brimful	<b>215 ml</b>
Weight	<b>300 g</b>
Height	<b>210.5 mm</b>
Diameter of body (max)	<b>55 mm</b>

## AVERAGE % OF RECYCLED CONTENT



## FINISH TYPE

	Bartop	Screw	Bayonete
			
<b>Cork 18.5</b>	—	—	—
<b>Vinolok 18.5</b>	—	—	—
—	—	—	—
—	—	—	—

# LAB GIN 2000 0.2 L | 200 ml

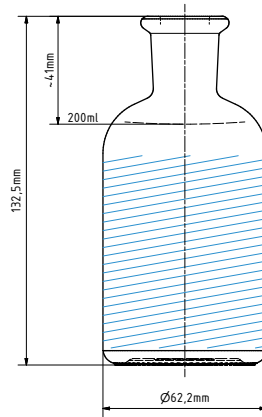



 Area for personalization





## SPECIFICATION

Volume	<b>200 ml</b>
Brimful	<b>220 ml</b>
Weight	<b>210 g</b>
Height	<b>132.5 mm</b>
Diameter of body (max)	<b>62.2 mm</b>

## AVERAGE % OF RECYCLED CONTENT

 Flint	<b>30+</b>	
 Amber	<b>70+</b>	
 Black	<b>75+</b>	

## FINISH TYPE

	Bartop	Screw	Bayonete
			
<b>Cork 18.5</b>	—	—	—
<b>Vinlok 18.5</b>	—	—	—
—	—	—	—
—	—	—	—

# PUZZLE 0.2 L | 200 ml

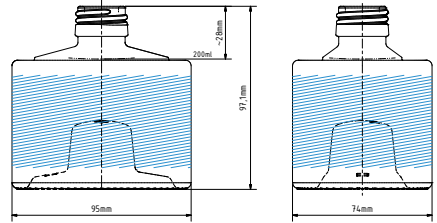

 Area for personalization



## SPECIFICATION

Volume	<b>200 ml</b>
Brimful	<b>212 ml</b>
Weight	<b>340 g</b>
Height	<b>97.1 mm</b>
Dimensions of body (max)	<b>95 × 74 mm</b>

## AVERAGE % OF RECYCLED CONTENT



## FINISH TYPE

Bartop	Screw	Bayonete
		
<b>Cork 18</b>	<b>PP 28</b>	<b>Guala 1031/47</b>
—	—	—
—	—	—
—	—	—



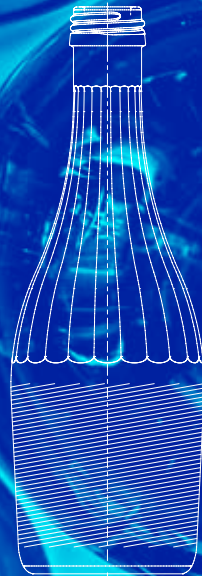



**VOLUME** 250 – 499 ml

---

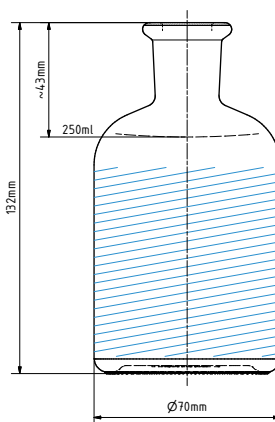

# LAB GIN 2000 0.25 L | 250 ml



 Area for personalization



## SPECIFICATION

Volume	<b>250 ml</b>
Brimful	<b>284 ml</b>
Weight	<b>225 g</b>
Height	<b>132 mm</b>
Diameter of body (max)	<b>70 mm</b>

## AVERAGE % OF RECYCLED CONTENT

○ Flint	<b>30+</b>	
● Amber	<b>70+</b>	
● Black	<b>75+</b>	

## FINISH TYPE

	Bartop	Screw	Bayonete
			
<b>Cork 18.5</b>	—	—	—
<b>Vinolok 18.5</b>	—	—	—
—	—	—	—
—	—	—	—

# MEPLAT 0.25 L | 250 ml

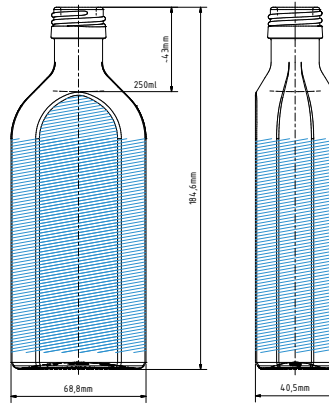

 Area for personalization



## SPECIFICATION

Volume	<b>250 ml</b>
Brimful	<b>264 ml</b>
Weight	<b>250 g</b>
Height	<b>184.6 mm</b>
Dimensions of body (max)	<b>68.8 × 40.5 mm</b>

## AVERAGE % OF RECYCLED CONTENT

○ Flint	<b>30+</b>	
● Amber	<b>70+</b>	
● Black	<b>75+</b>	

## FINISH TYPE

Bartop	Screw	Bayonete
		
—	<b>PP 28</b>	—
—	<b>MCA 2</b>	—
—	<b>B 22</b>	—
—	—	—



# SAGA 0.25 L | 250 ml

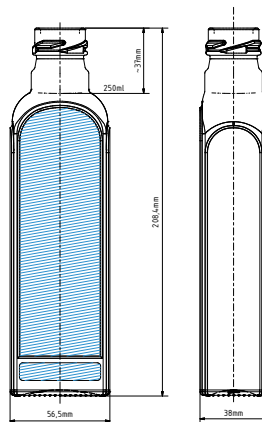

 Area for personalization



## SPECIFICATION

Volume	<b>250 ml</b>
Brimful	<b>265 ml</b>
Weight	<b>265 g</b>
Height	<b>208.4 mm</b>
Dimensions of body (max)	<b>56.5 × 38 mm</b>

## AVERAGE % OF RECYCLED CONTENT



## FINISH TYPE

Bartop	Screw	Bayonete
		
<b>Cork 18.5</b>	<b>PP 31.5 × 18</b>	<b>Guala 1031/47</b>
<b>Vinolok 18.5</b>	<b>TO 33</b>	—
—	—	—
—	—	—

# DOBRA VODA 0.33 L | 330 ML

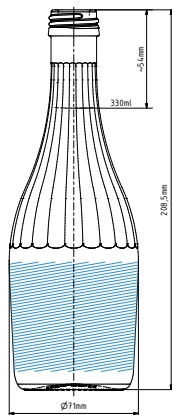



 Area for personalization



## SPECIFICATION

Volume	<b>330 ml</b>
Brimful	<b>345 ml</b>
Weight	<b>350 g</b>
Height	<b>208.5 mm</b>
Diameter of body (max)	<b>71 mm</b>

## AVERAGE % OF RECYCLED CONTENT

 Flint	<b>30+</b>	
 Amber	<b>70+</b>	
 Black	<b>75+</b>	

## FINISH TYPE

Bartop	Screw	Bayonete
		
—	<b>PP 28</b>	—
—	<b>MCA</b>	—
—	—	—
—	—	—

# CLIPPER 0.35 L | 350 ml

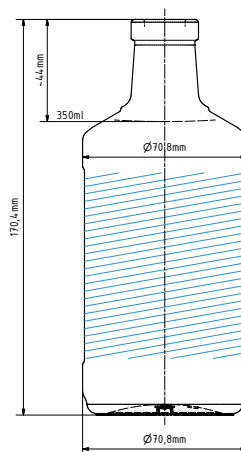

 Area for personalization



## SPECIFICATION

Volume	<b>350 ml</b>
Brimful	<b>369 ml</b>
Weight	<b>330 g</b>
Height	<b>170.4 mm</b>
Diameter of body (max)	<b>70.8 mm</b>

## AVERAGE % OF RECYCLED CONTENT



## FINISH TYPE

	Bartop	Screw	Bayonete
	<input checked="" type="checkbox"/>	<input type="checkbox"/>	<input type="checkbox"/>
	<input type="checkbox"/>	<input checked="" type="checkbox"/>	<input type="checkbox"/>
	<input type="checkbox"/>	<input type="checkbox"/>	<input checked="" type="checkbox"/>
<b>Cork 17.5</b>	<input type="checkbox"/>	<input type="checkbox"/>	<input type="checkbox"/>
<input type="checkbox"/>	<input type="checkbox"/>	<input type="checkbox"/>	<input type="checkbox"/>
<input type="checkbox"/>	<input type="checkbox"/>	<input type="checkbox"/>	<input type="checkbox"/>

# GKW 0.35 L | 350 ml

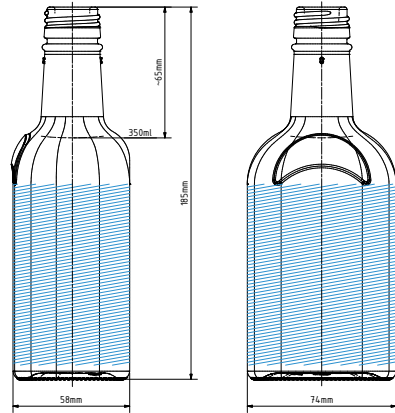



 Area for personalization



## SPECIFICATION

Volume	<b>350 ml</b>
Brimful	<b>375 ml</b>
Weight	<b>345 g</b>
Height	<b>185 mm</b>
Diameter of body (max)	<b>74 × 58 mm</b>

## AVERAGE % OF RECYCLED CONTENT

 Flint	<b>30+</b>	
 Amber	<b>70+</b>	
 Black	<b>75+</b>	

## FINISH TYPE

Bartop	Screw	Bayonete
		
—	<b>PP 31.5 × 24</b>	—
—	<b>PP 28</b>	—
—	—	—
—	—	—

# CREAM LIQUER 0.375 L | 375 ml

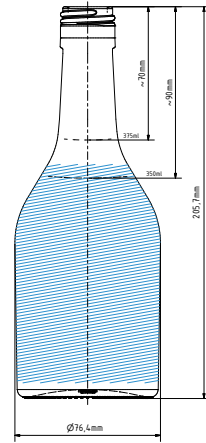

 Area for personalization



## SPECIFICATION

Volume	<b>375 ml</b>
Brimful	<b>395 ml</b>
Weight	<b>380 g</b>
Height	<b>205.7 mm</b>
Diameter of body (max)	<b>76.4 mm</b>

## AVERAGE % OF RECYCLED CONTENT



## FINISH TYPE

Bartop	Screw	Bayonete
		
<b>Cork 18.5</b>	<b>PP 30 × 60</b>	—
<b>Vinolok 18.5</b>	<b>MCA 2</b>	—
—	<b>PP 30 × 60 DZ</b>	—
—	—	—

# VINO 0.375 L | 375 ml

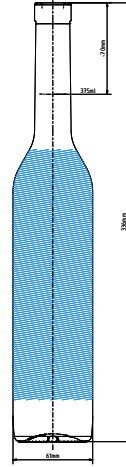



 Area for personalization

## SPECIFICATION

Volume	<b>375 ml</b>
Brimful	<b>395 ml</b>
Weight	<b>735 g</b>
Height	<b>336 mm</b>
Diameter of body (max)	<b>61 mm</b>

## AVERAGE % OF RECYCLED CONTENT

○ Flint	<b>30+</b>	
● Amber	<b>70+</b>	
● Black	<b>75+</b>	

## FINISH TYPE

	Bartop	Screw	Bayonete
	<input checked="" type="checkbox"/>	<input type="checkbox"/>	<input type="checkbox"/>
<b>Cork 17.5</b>	<input type="checkbox"/>	<input type="checkbox"/>	<input type="checkbox"/>
<input type="checkbox"/>	<input type="checkbox"/>	<input type="checkbox"/>	<input type="checkbox"/>
<input type="checkbox"/>	<input type="checkbox"/>	<input type="checkbox"/>	<input type="checkbox"/>
<input type="checkbox"/>	<input type="checkbox"/>	<input type="checkbox"/>	<input type="checkbox"/>

**VOLUME** 500 – 699 ml

---

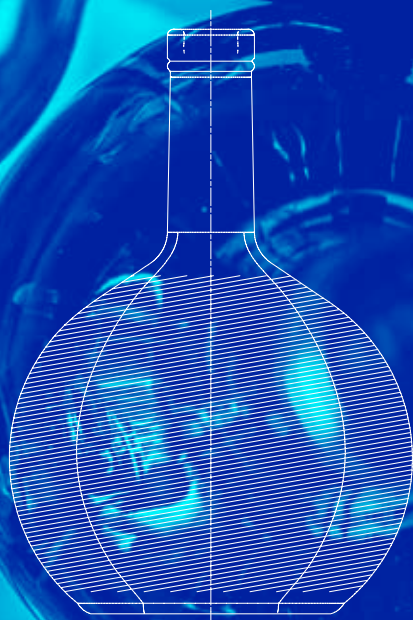





# ANTON 0.5 L | 500 ml

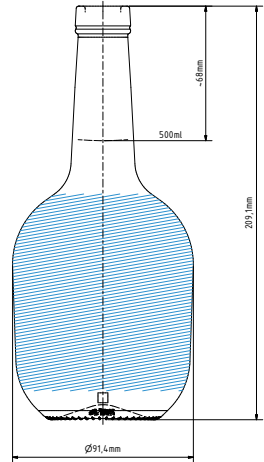

 Area for personalization



## SPECIFICATION

Volume	<b>500 ml</b>
Brimful	<b>520 ml</b>
Weight	<b>430 g</b>
Height	<b>209.1 mm</b>
Diameter of body (max)	<b>91.4 mm</b>

## AVERAGE % OF RECYCLED CONTENT

 Flint	<b>30+</b>	
 Amber	<b>70+</b>	
 Black	<b>75+</b>	

## FINISH TYPE

Bartop	Screw	Bayonete
		
<b>Cork 18</b>	<b>PP 28</b>	—
—	—	—
—	—	—
—	—	—

# B-LUX 0.5 L | 500 ml

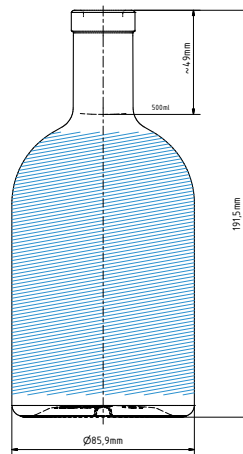



 Area for personalization



## SPECIFICATION

Volume	<b>500 ml</b>
Brimful	<b>517 ml</b>
Weight	<b>600 g</b>
Height	<b>191.5 mm</b>
Diameter of body (max)	<b>85.9 mm</b>

## AVERAGE % OF RECYCLED CONTENT

○ Flint	<b>30+</b>	
● Amber	<b>70+</b>	
● Black	<b>75+</b>	

## FINISH TYPE

Bartop	Screw	Bayonete
		
<b>Cork 18.5</b>	<b>GPI 400/28</b>	—
<b>Vinolok 18.5</b>	<b>PP 31.5 × 24</b>	—
<b>Vinolok 21.5</b>	—	—
—	—	—

# BAB 0.5 L | 500 ml

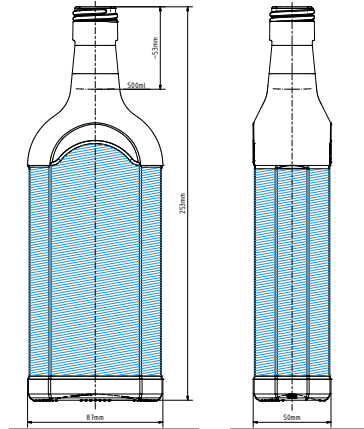

 Area for personalization

## SPECIFICATION

Volume	<b>500 ml</b>
Brimful	<b>515 ml</b>
Weight	<b>500 g</b>
Height	<b>253 mm</b>
Diameter of body (max)	<b>87 × 50 mm</b>

## AVERAGE % OF RECYCLED CONTENT



## FINISH TYPE

Bartop	Screw	Bayonete
		
—	<b>PP 30 × 44</b>	—
—	—	—
—	—	—
—	—	—

# BARON 0.5 L | 500 ml

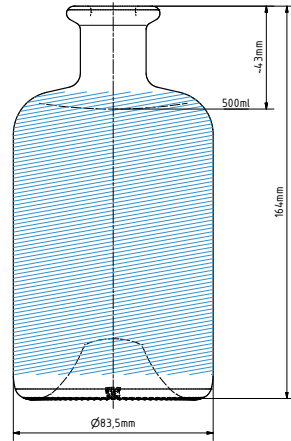

 Area for personalization



## SPECIFICATION

Volume	<b>500 ml</b>
Brimful	<b>527 ml</b>
Weight	<b>390 g</b>
Height	<b>164 mm</b>
Diameter of body (max)	<b>83.5 mm</b>

## AVERAGE % OF RECYCLED CONTENT

○ Flint	<b>30+</b>	
● Amber	<b>70+</b>	
● Black	<b>75+</b>	

## FINISH TYPE

	Bartop	Screw	Bayonete
			
<b>Cork 18.5</b>	—	—	—
<b>Vinolok 18.5</b>	—	—	—
—	—	—	—
—	—	—	—

# CAHIR 0.5 L | 500 ml

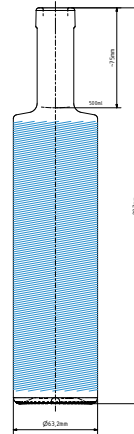



 Area for personalization



## SPECIFICATION

Volume	<b>500 ml</b>
Brimful	<b>525 ml</b>
Weight	<b>500 g</b>
Height	<b>297 mm</b>
Diameter of body (max)	<b>63.2 mm</b>

## AVERAGE % OF RECYCLED CONTENT

 Flint	<b>30+</b>	
 Amber	<b>70+</b>	
 Black	<b>75+</b>	

## FINISH TYPE

Bartop	Screw	Bayonete
		
<b>Cork 18.5</b>	<b>PP 31.5 × 24</b>	—
<b>Vinolok 18.5</b>	—	—
—	—	—
—	—	—

# CLIPPER 0.5 L | 500 ml

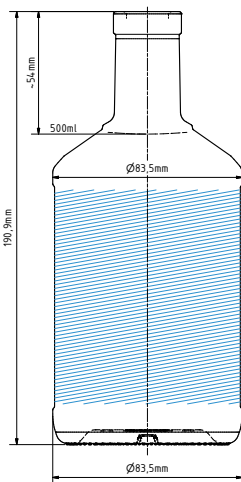

 Area for personalization



## SPECIFICATION

Volume	<b>500 ml</b>
Brimful	<b>522 ml</b>
Weight	<b>450 g</b>
Height	<b>191 mm</b>
Diameter of body (max)	<b>83.5 mm</b>

## AVERAGE % OF RECYCLED CONTENT

○ Flint	<b>30+</b>	
● Amber	<b>70+</b>	
● Black	<b>75+</b>	

## FINISH TYPE

Bartop	Screw	Bayonete
		
<b>Cork 18.5</b>	<b>GPI 400/28</b>	—
<b>Vinlok 18.5</b>	—	—
—	—	—
—	—	—

# CREAM LIQUER 0.5 L | 500 ml

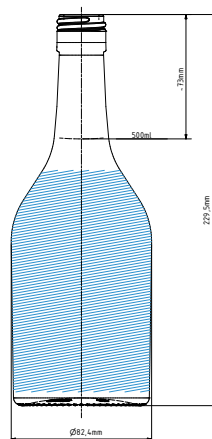

 Area for personalization



## SPECIFICATION

Volume	<b>500 ml</b>
Brimful	<b>527 ml</b>
Weight	<b>472 g</b>
Height	<b>229.5 mm</b>
Diameter of body (max)	<b>82.4 mm</b>

## AVERAGE % OF RECYCLED CONTENT



## FINISH TYPE

Bartop	Screw	Bayonete
		
<b>Cork 18.5</b>	<b>PP 30 × 60</b>	—
<b>Vinolok 18.5</b>	<b>MCA 2</b>	—
—	<b>PP 30 × 60 DZ</b>	—
—	—	—

# DURANA 0.5 L | 500 ml

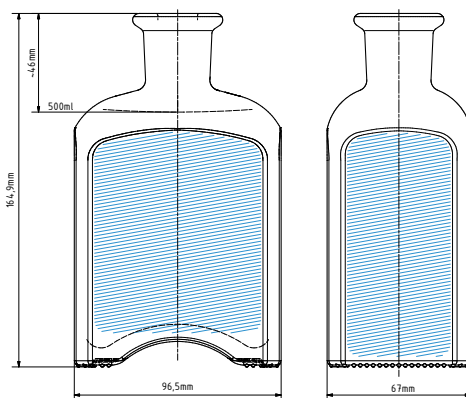

 Area for personalization



## SPECIFICATION

Volume	<b>500 ml</b>
Brimful	<b>530 ml</b>
Weight	<b>600 g</b>
Height	<b>164.9 mm</b>
Dimensions of body (max)	<b>96.5 × 67 mm</b>

## AVERAGE % OF RECYCLED CONTENT

○ Flint	<b>30+</b>	
● Amber	<b>70+</b>	
● Black	<b>75+</b>	

## FINISH TYPE

	Bartop	Screw	Bayonete
			
<b>Cork 18.5</b>	—	—	—
<b>Vinolok 18.5</b>	—	—	—
<b>Cork 21.5</b>	—	—	—
<b>Vinolok 21.5</b>	—	—	—



# GIN D 0.5 L | 500 ml

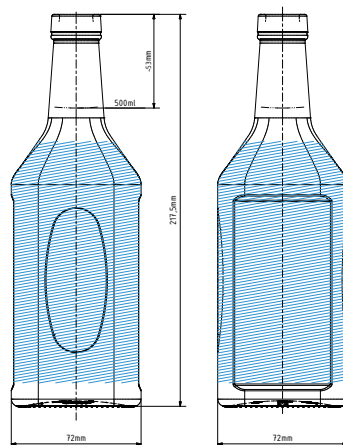

 Area for personalization



## SPECIFICATION

Volume	<b>500 ml</b>
Brimful	<b>515 ml</b>
Weight	<b>440 g</b>
Height	<b>217.5 mm</b>
Dimensions of body (max)	<b>72 × 72 mm</b>

## AVERAGE % OF RECYCLED CONTENT



## FINISH TYPE

Bartop	Screw	Bayonete
		
<b>Cork 18.5</b>	<b>PP 28</b>	—
<b>Vinotok 18.5</b>	—	—
—	—	—
—	—	—

# GRAPES 0.5 L | 500 ml

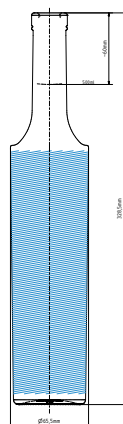



 Area for personalization



## SPECIFICATION

Volume	<b>500 ml</b>
Brimful	<b>520 ml</b>
Weight	<b>600 g</b>
Height	<b>328.5 mm</b>
Diameter of body (max)	<b>65.5 mm</b>

## AVERAGE % OF RECYCLED CONTENT

○ Flint	<b>30+</b>	
● Amber	<b>70+</b>	
● Black	<b>75+</b>	

## FINISH TYPE

Bartop	Screw	Bayonete
		
<b>Cork 18</b>	<b>PP 31.5</b>	—
<b>Vinlok 18.5</b>	—	—
<b>Vinlok 21.5</b>	—	—
—	—	—

# KIRSCHWASSER 0.5 L | 500 ml

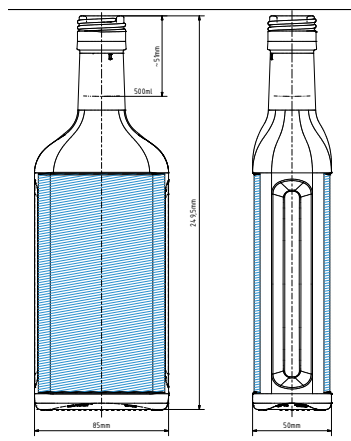

 Area for personalization



## SPECIFICATION

Volume	<b>500 ml</b>
Brimful	<b>515 ml</b>
Weight	<b>490 g</b>
Height	<b>249.5 mm</b>
Diameter of body (max)	<b>85 × 50 mm</b>

## AVERAGE % OF RECYCLED CONTENT

<input type="radio"/> Flint	<b>30+</b>	
<input checked="" type="radio"/> Amber	<b>70+</b>	
<input checked="" type="radio"/> Black	<b>75+</b>	

## FINISH TYPE

Bartop	Screw	Bayonete
		
<b>Cork 18.4</b>	<b>PP 31.5 × 24</b>	—
—	—	—
—	—	—
—	—	—

# LAB CREAM 0.5 L | 500 ml

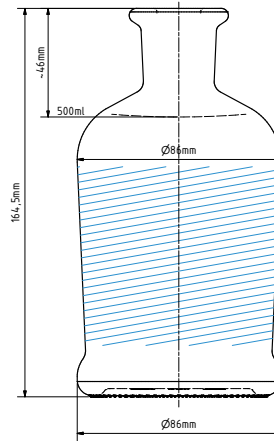



 Area for personalization



## SPECIFICATION

Volume	<b>500 ml</b>
Brimful	<b>525 ml</b>
Weight	<b>380 g</b>
Height	<b>164.5 mm</b>
Diameter of body	<b>86 mm</b>

## AVERAGE % OF RECYCLED CONTENT

○ Flint	<b>30+</b>	
● Amber	<b>70+</b>	
● Black	<b>75+</b>	

## FINISH TYPE

	Bartop	Screw	Bayonete
			
<b>Cork 18.5</b>	—	—	—
<b>Vinlok 18.5</b>	—	—	—
<b>Vinlok 21.5</b>	—	—	—
—	—	—	—

# LAB GIN 2000 0.5 L | 500 ml

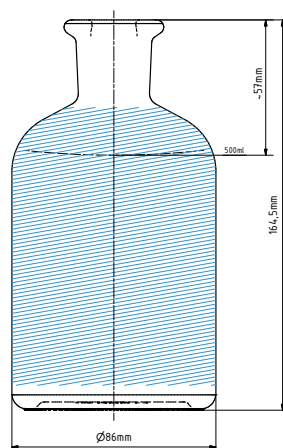

 Area for personalization



## SPECIFICATION

Volume	<b>500 ml</b>
Brimful	<b>566 ml</b>
Weight	<b>380 g</b>
Height	<b>164.5 mm</b>
Diameter of body	<b>86 mm</b>

## AVERAGE % OF RECYCLED CONTENT

 Flint	<b>30+</b>	
 Amber	<b>70+</b>	
 Black	<b>75+</b>	

## FINISH TYPE

	Bartop	Screw	Bayonete
			
<b>Cork 18.5</b>	—	—	—
<b>Vinolok 18.5</b>	—	—	—
<b>Vinolok 21.5</b>	—	—	—
—	—	—	—

# LAB GIN 2008 0.5 L | 500 ml

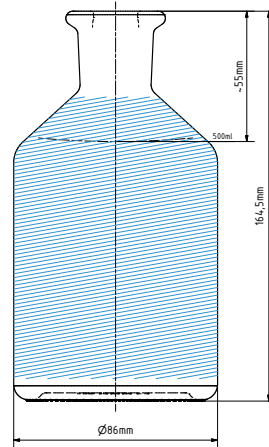



 Area for personalization



## SPECIFICATION

Volume	<b>500 ml</b>
Brimful	<b>545 ml</b>
Weight	<b>400 g</b>
Height	<b>164.5 mm</b>
Diameter of body	<b>86 mm</b>

## AVERAGE % OF RECYCLED CONTENT

○ Flint	<b>30+</b>	
● Amber	<b>70+</b>	
● Black	<b>75+</b>	

## FINISH TYPE

	Bartop	Screw	Bayonete
			
<b>Cork 18.5</b>	—	—	—
<b>Vinolok 18.5</b>	—	—	—
<b>Vinolok 21.5</b>	—	—	—
—	—	—	—

# LAB ME 0.5 L | 500 ml

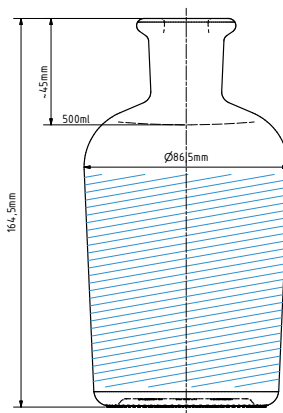

 Area for personalization





## SPECIFICATION

Volume	<b>500 ml</b>
Brimful	<b>525 ml</b>
Weight	<b>380 g</b>
Height	<b>164.5 mm</b>
Diameter of body	<b>86.5 mm</b>

## AVERAGE % OF RECYCLED CONTENT

 Flint	<b>30+</b>	
 Amber	<b>70+</b>	
 Black	<b>75+</b>	

## FINISH TYPE

	Bartop	Screw	Bayonete
			
<b>Cork 18.5</b>	—	—	—
<b>Vinolok 18.5</b>	—	—	—
<b>Vinolok 21.5</b>	—	—	—
—	—	—	—

# LEON 0.5 L | 500 ml

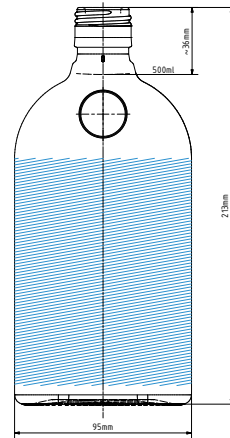



 Area for personalization



## SPECIFICATION

Volume	<b>500 ml</b>
Brimful	<b>520 ml</b>
Weight	<b>400 g</b>
Height	<b>213 mm</b>
Diameter of body (max)	<b>95 × 47 mm</b>

## AVERAGE % OF RECYCLED CONTENT

 Flint	<b>30+</b>	
 Amber	<b>70+</b>	
 Black	<b>75+</b>	

## FINISH TYPE

Bartop	Screw	Bayonete
		
—	<b>PP 31.5 × 24</b>	—
—	—	—
—	—	—
—	—	—



# MEPLAT 0.5 L | 500 ml

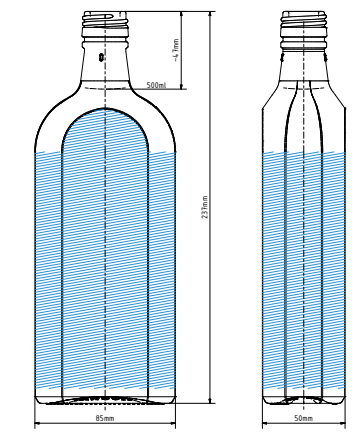

 Area for personalization



## SPECIFICATION

Volume	<b>500 ml</b>
Brimful	<b>515 ml</b>
Weight	<b>485 g</b>
Height	<b>237 mm</b>
Diameter of body (max)	<b>85 × 50 mm</b>

## AVERAGE % OF RECYCLED CONTENT



## FINISH TYPE

Bartop	Screw	Bayonete
		
—	<b>PP 28 × 38</b>	—
—	<b>B 22</b>	—
—	—	—
—	—	—

# MORELLA 0.5 L | 500 ml

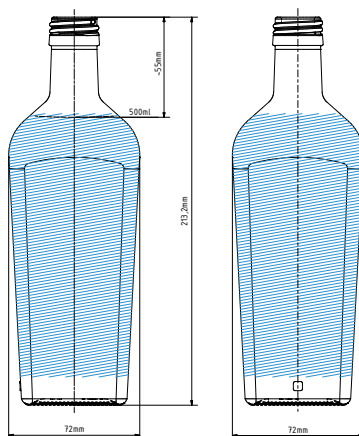



 Area for personalization



## SPECIFICATION

Volume	<b>500 ml</b>
Brimful	<b>520 ml</b>
Weight	<b>410 g</b>
Height	<b>213.2 mm</b>
Dimensions of body (max)	<b>72 × 72 mm</b>

## AVERAGE % OF RECYCLED CONTENT

○ Flint	<b>30+</b>	
● Amber	<b>70+</b>	
● Black	<b>75+</b>	

## FINISH TYPE

Bartop	Screw	Bayonete
		
<b>Cork 18.5</b>	<b>PP 28 S</b>	—
<b>Vinolok 18.5</b>	—	—
—	—	—
—	—	—

# PULY 0.5 L | 500 ml

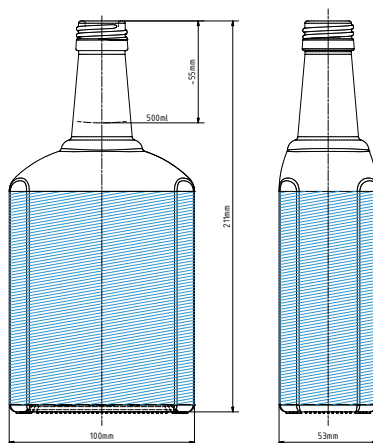

 Area for personalization



## SPECIFICATION

Volume	<b>500 ml</b>
Brimful	<b>520 ml</b>
Weight	<b>510 g</b>
Height	<b>211 mm</b>
Dimensions of body (max)	<b>100 × 53 mm</b>

## AVERAGE % OF RECYCLED CONTENT

<input type="radio"/> Flint	<b>30+</b>	
<input type="radio"/> Amber	<b>70+</b>	
<input type="radio"/> Black	<b>75+</b>	

## FINISH TYPE

Bartop	Screw	Bayonete
		
<b>Cork 17.5</b>	<b>PP 28</b>	—
—	—	—
—	—	—
—	—	—

# SAGA 0.5 L | 500 ml

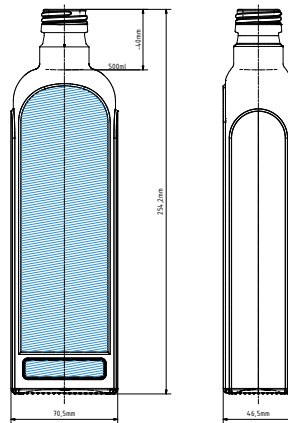

 Area for personalization



## SPECIFICATION

Volume	<b>500 ml</b>
Brimful	<b>515 ml</b>
Weight	<b>460 g</b>
Height	<b>254.2 mm</b>
Dimensions of body (max)	<b>70.5 × 46.5 mm</b>

## AVERAGE % OF RECYCLED CONTENT

○ Flint	<b>30+</b>	
● Amber	<b>70+</b>	
● Black	<b>75+</b>	

## FINISH TYPE

Bartop	Screw	Bayonete
		
<b>Cork 18.5</b>	<b>PP 31.5 × 18</b>	<b>Guala 1031/47</b>
<b>Vinolok 18.5</b>	<b>TO 33</b>	—
—	—	—
—	—	—

# SAMTREST 0.5 L | 500 ml

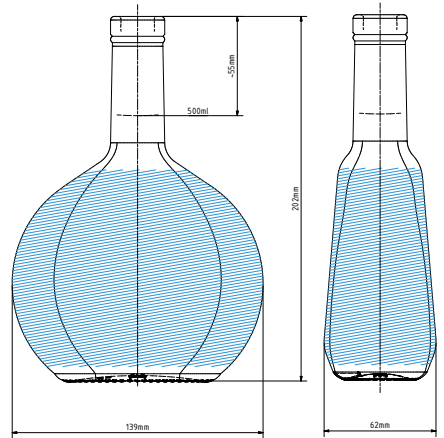

 Area for personalization



## SPECIFICATION

Volume	<b>500 ml</b>
Brimful	<b>520 ml</b>
Weight	<b>475 g</b>
Height	<b>202 mm</b>
Dimensions of body (max)	<b>62 × 139 mm</b>

## AVERAGE % OF RECYCLED CONTENT

 Flint	<b>30+</b>	
 Amber	<b>70+</b>	
 Black	<b>75+</b>	

## FINISH TYPE

Bartop	Screw	Bayonete
		
<b>Cork 18.5</b>	<b>PP 28</b>	—
<b>Vinolok 18.5</b>	—	—
<b>Vinolok 21.5</b>	—	—
—	—	—

# STANDARD KOŇAK 0.5 L | 500 ml

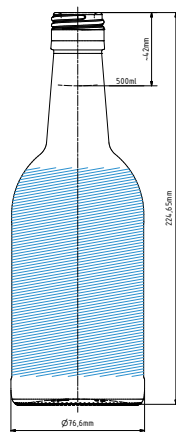

 Area for personalization



## SPECIFICATION

Volume	<b>500 ml</b>
Brimful	<b>514 ml</b>
Weight	<b>390 g</b>
Height	<b>225 mm</b>
Diameter of body (max)	<b>76.6 mm</b>

## AVERAGE % OF RECYCLED CONTENT

○ Flint	<b>30+</b>	
● Amber	<b>70+</b>	
● Black	<b>75+</b>	

## FINISH TYPE

Bartop	Screw	Bayonete
		
<b>Cork 18.4</b>	<b>PP 31.5 × 24</b>	—
—	—	—
—	—	—
—	—	—

# VICE 0.5 L | 500 ml

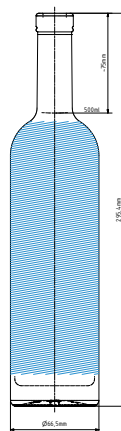

 Area for personalization





## SPECIFICATION

Volume	<b>500 ml</b>
Brimful	<b>520 ml</b>
Weight	<b>600 g</b>
Height	<b>295 mm</b>
Diameter of body (max)	<b>66.5 mm</b>

## AVERAGE % OF RECYCLED CONTENT

○ Flint	<b>30+</b>	
● Amber	<b>70+</b>	
● Black	<b>75+</b>	

## FINISH TYPE

	Bartop	Screw	Bayonete
			
<b>Cork 17.5</b>	—	—	—
<b>Vinolok 17.5</b>	—	—	—
—	—	—	—
—	—	—	—

# VINO 0.5 L | 500 ml

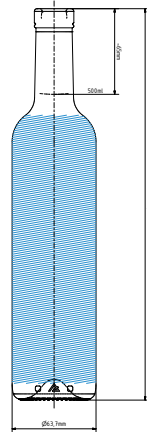

 Area for personalization



## SPECIFICATION

Volume	<b>500 ml</b>
Brimful	<b>520 ml</b>
Weight	<b>510 g</b>
Height	<b>298 mm</b>
Diameter of body (max)	<b>63.7 mm</b>

## AVERAGE % OF RECYCLED CONTENT

○ Flint	<b>30+</b>	
● Amber	<b>70+</b>	
● Black	<b>75+</b>	

## FINISH TYPE

Bartop	Screw	Bayonete
		
<b>Cork 18.4</b>	<b>PP 31.5 × 24</b>	—
<b>Vinolok 18.5</b>	<b>PP 28</b>	—
—	<b>GPI 400/28</b>	—
—	—	—



# VODKA BOTTLE 0.5 L | 500 ml

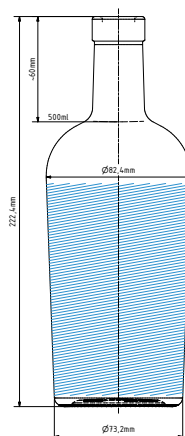

 Area for personalization



## SPECIFICATION

Volume	<b>500 ml</b>
Brimful	<b>523 ml</b>
Weight	<b>640 g</b>
Height	<b>222 mm</b>
Diameter of body (max)	<b>82.4 mm</b>

## AVERAGE % OF RECYCLED CONTENT



## FINISH TYPE

Bartop	Screw	Bayonete
		
<b>Cork 18.5</b>	<b>GPI 400/28</b>	—
<b>Vinolok 18.5</b>	—	—
—	—	—
—	—	—

# WATER CRISTAL 0.5 L | 500 ml

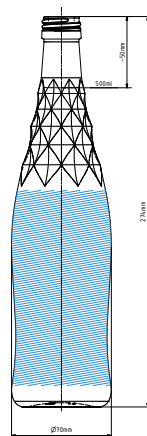

 Area for personalization



## SPECIFICATION

Volume	<b>500 ml</b>
Brimful	<b>515 ml</b>
Weight	<b>430 g</b>
Height	<b>274 mm</b>
Diameter of body (max)	<b>70 mm</b>

## AVERAGE % OF RECYCLED CONTENT

○ Flint	<b>30+</b>	
● Amber	<b>70+</b>	
● Black	<b>75+</b>	

## FINISH TYPE

Bartop	Screw	Bayonete
		
<b>Cork 17.5</b>	<b>PP 28</b>	—
—	—	—
—	—	—
—	—	—

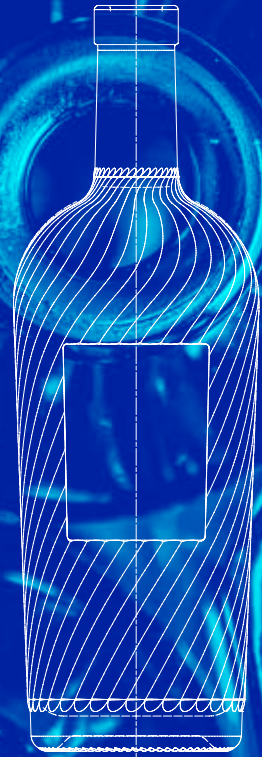



**VOLUME** 700 – 999 ml

---

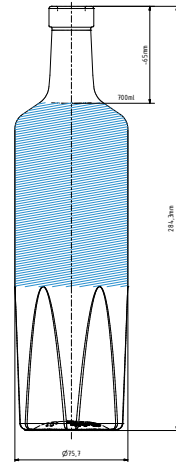

# ALEXANDER 0.7 L | 700 ml



 Area for personalization



## SPECIFICATION

Volume	<b>700 ml</b>
Brimful	<b>723 ml</b>
Weight	<b>650 g</b>
Height	<b>284.3 mm</b>
Diameter of body (max)	<b>75.7 mm</b>

## AVERAGE % OF RECYCLED CONTENT



## FINISH TYPE

Bartop	Screw	Bayonete
		
<b>Cork 18.5</b>	<b>PP 30 × 60</b>	—
<b>Vinolok 18.5</b>	—	—
—	—	—
—	—	—

# B-LUX 0.7 L | 700 ml

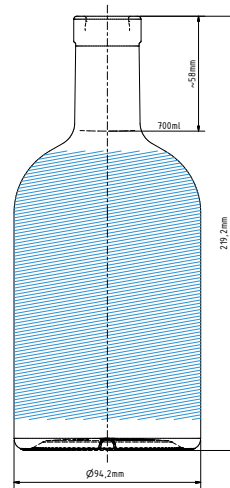

 Area for personalization



## SPECIFICATION

Volume	<b>700 ml</b>
Brimful	<b>728 ml</b>
Weight	<b>800 g</b>
Height	<b>219.2 mm</b>
Diameter of body (max)	<b>94.2 mm</b>

## AVERAGE % OF RECYCLED CONTENT

○ Flint	<b>30+</b>	
● Amber	<b>70+</b>	
● Black	<b>75+</b>	

## FINISH TYPE

Bartop	Screw	Bayonete
		
<b>Cork 18.5</b>	<b>GPI 400/33</b>	—
<b>Vinolok 18.5</b>	—	—
<b>Vinolok 21.5</b>	—	—
—	—	—

# BARON 0.7 L | 700 ml

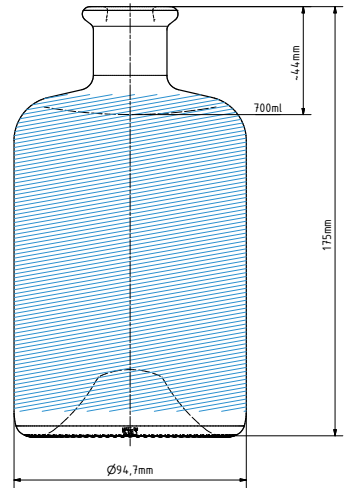

 Area for personalization



## SPECIFICATION

Volume	<b>700 ml</b>
Brimful	<b>730 ml</b>
Weight	<b>530 g</b>
Height	<b>175 mm</b>
Diameter of body (max)	<b>94.7 mm</b>

## AVERAGE % OF RECYCLED CONTENT



## FINISH TYPE

	Bartop	Screw	Bayonete
			
<b>Cork 18.5</b>	—	—	—
<b>Vinolok 18.5</b>	—	—	—
<b>Vinolok 21.5</b>	—	—	—
—	—	—	—

# BARRACUDA 0.7 L | 700 ml

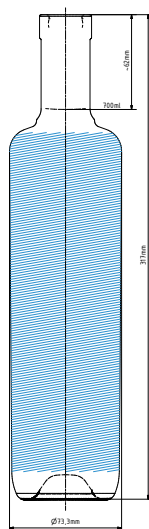

 Area for personalization



## SPECIFICATION

Volume	<b>700 ml</b>
Brimful	<b>728 ml</b>
Weight	<b>720 g</b>
Height	<b>317 mm</b>
Diameter of body	<b>73.3 mm</b>

## AVERAGE % OF RECYCLED CONTENT

 Flint	<b>30+</b>	
 Amber	<b>70+</b>	
 Black	<b>75+</b>	

## FINISH TYPE

	Bartop	Screw	Bayonete
			
<b>Cork 21.5</b>	—	—	—
<b>Vinlok 21.5</b>	—	—	—
—	—	—	—
—	—	—	—



# BOTTLE ICE 0.7 L | 700 ml

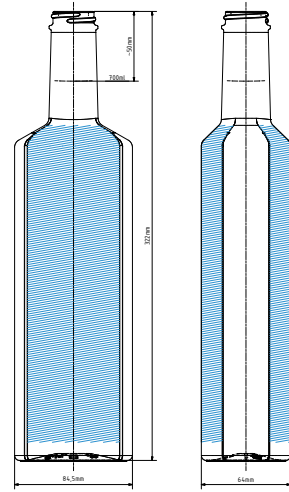

 Area for personalization



## SPECIFICATION

Volume	<b>700 ml</b>
Brimful	<b>725 ml</b>
Weight	<b>760 g</b>
Height	<b>322 mm</b>
Dimensions of body (max)	<b>84.5 × 64 mm</b>

## AVERAGE % OF RECYCLED CONTENT

<input type="radio"/> Flint	<b>30+</b>	
<input type="radio"/> Amber	<b>70+</b>	
<input type="radio"/> Black	<b>75+</b>	

## FINISH TYPE

	Bartop	Screw	Bayonete
			
<b>Cork 18.5</b>		<b>GPI 400/33</b>	—
<b>Vinolok 18.5</b>		—	—
<b>Vinolok 21.5</b>		—	—
—	—	—	—

# CLIPPER 0.7 L | 700 ml

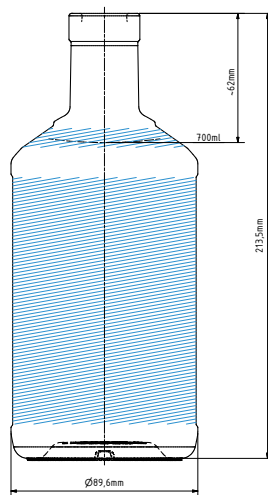

 Area for personalization



## SPECIFICATION

Volume	<b>700 ml</b>
Brimful	<b>740 ml</b>
Weight	<b>570 g</b>
Height	<b>213.5 mm</b>
Diameter of body	<b>89.6 mm</b>

## AVERAGE % OF RECYCLED CONTENT

○ Flint	<b>30+</b>	
● Amber	<b>70+</b>	
● Black	<b>75+</b>	

## FINISH TYPE

Bartop	Screw	Bayonete
		
<b>Cork 18.5</b>	<b>GPI 400M/35</b>	—
<b>Vinolok 18.5</b>	—	—
—	—	—
—	—	—

# CREAM LIQUER 0.7 L | 700 ml

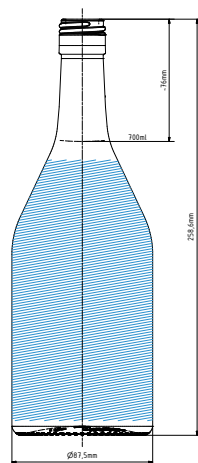

 Area for personalization



## SPECIFICATION

Volume	<b>700 ml</b>
Brimful	<b>727 ml</b>
Weight	<b>560 g</b>
Height	<b>258.6 mm</b>
Diameter of body (max)	<b>87.5 mm</b>

## AVERAGE % OF RECYCLED CONTENT

 Flint	<b>30+</b>	
 Amber	<b>70+</b>	
 Black	<b>75+</b>	

## FINISH TYPE

Bartop	Screw	Bayonete
		
<b>Cork 18.5</b>	<b>PP 30 × 60</b>	—
<b>Vinolok 18.5</b>	<b>MCA 2</b>	—
—	<b>PP 30 × 60 DZ</b>	—
—	—	—

# DURANA 0.7L | 700 ml

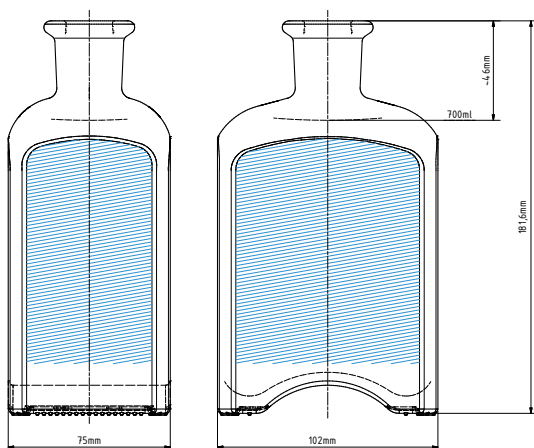

 Area for personalization



## SPECIFICATION

Volume	<b>700 ml</b>
Brimful	<b>730 ml</b>
Weight	<b>760 g</b>
Height	<b>181.6 mm</b>
Diameter of body	<b>102 × 75 mm</b>

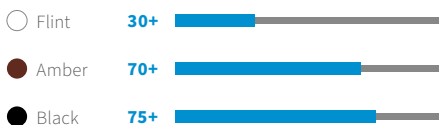
## AVERAGE % OF RECYCLED CONTENT



## FINISH TYPE

	Bartop	Screw	Bayonete
			
<b>Cork 18.5</b>	—	—	—
<b>Vinolok 18.5</b>	—	—	—
<b>Cork 21.5</b>	—	—	—
<b>Vinolok 21.5</b>	—	—	—

# GIN D 0.7 L | 700 ml

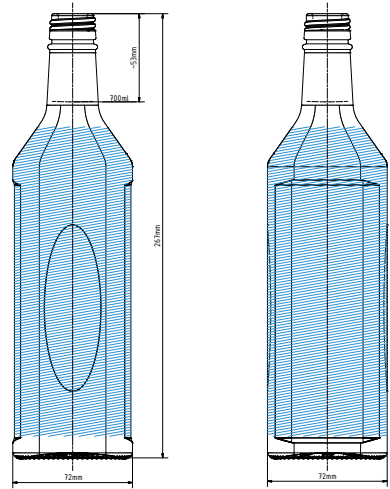

 Area for personalization



## SPECIFICATION

Volume	<b>700 ml</b>
Brimful	<b>720 ml</b>
Weight	<b>560 g</b>
Height	<b>267 mm</b>
Diameter of body (max)	<b>72 × 72 mm</b>

## AVERAGE % OF RECYCLED CONTENT



## FINISH TYPE

Bartop	Screw	Bayonete
		
<b>Vinolok 18.5</b>	<b>PP 31.5 × 24</b>	—
<b>Vinolok 21.5</b>	<b>PP28</b>	—
—	—	—
—	—	—

# GKW 0.7 L | 700 ml

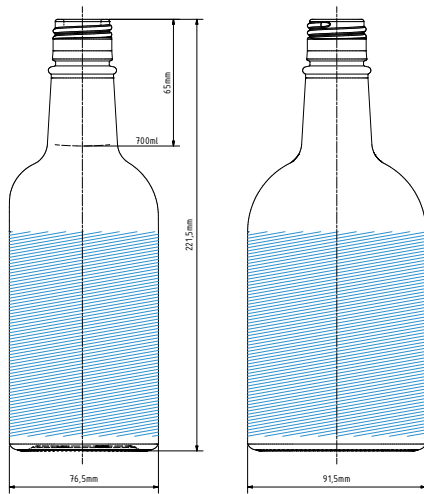

 Area for personalization



## SPECIFICATION

Volume	<b>700 ml</b>
Brimful	<b>730 ml</b>
Weight	<b>580 g</b>
Height	<b>221 mm</b>
Diameter of body (max)	<b>91.5 × 76.5 mm</b>

## AVERAGE % OF RECYCLED CONTENT

 Flint	<b>30+</b>	
 Amber	<b>70+</b>	
 Black	<b>75+</b>	

## FINISH TYPE

Bartop	Screw	Bayonete
		
—	<b>PP 31.5 × 24</b>	—
—	—	—
—	—	—
—	—	—

# GRAD 0.7 L | 700 ml

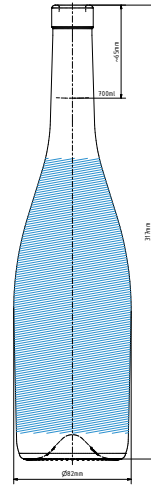

 Area for personalization



## SPECIFICATION

Volume	<b>700 ml</b>
Brimful	<b>720 ml</b>
Weight	<b>590 g</b>
Height	<b>317 mm</b>
Diameter of body (max)	<b>78 mm</b>

## AVERAGE % OF RECYCLED CONTENT

 Flint	<b>30+</b>	
 Amber	<b>70+</b>	
 Black	<b>75+</b>	

## FINISH TYPE

	Bartop	Screw	Bayonete
			
<b>Cork 18</b>	—	<b>PP 31.5 × 24</b>	—
<b>Vinolok 18.5</b>	—	—	—
<b>Vinolok 21.5</b>	—	—	—
—	—	—	—

# HIBERNIA 0.7 L | 700 ml

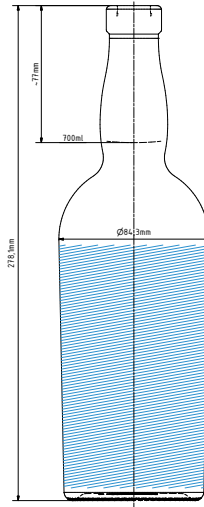



 Area for personalization



## SPECIFICATION

Volume	<b>700 ml</b>
Brimful	<b>730 ml</b>
Weight	<b>640 g</b>
Height	<b>278.1 mm</b>
Diameter of body (max)	<b>84.3 mm</b>

## AVERAGE % OF RECYCLED CONTENT

○ Flint	<b>30+</b>	
● Amber	<b>70+</b>	
● Black	<b>75+</b>	

## FINISH TYPE

Bartop	Screw	Bayonete
		
<b>Cork 18.5</b>	<b>PP 31.5</b>	—
<b>Vinolok 18.5</b>	—	—
—	—	—
—	—	—



# KAROLAN 0.7 L | 700 ml

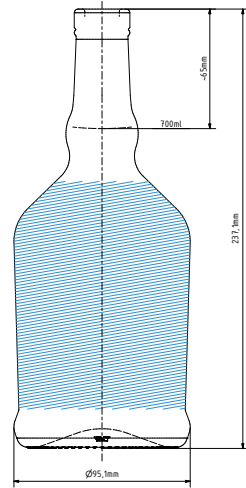

 Area for personalization



## SPECIFICATION

Volume	<b>700 ml</b>
Brimful	<b>730 ml</b>
Weight	<b>620 g</b>
Height	<b>237.1 mm</b>
Diameter of body (max)	<b>95.1 mm</b>

## AVERAGE % OF RECYCLED CONTENT



## FINISH TYPE

Bartop	Screw	Bayonete
		
<b>Cork 18.5</b>	<b>PP 31.5 × 60</b>	—
<b>Vinolok 18.5</b>	—	—
—	—	—
—	—	—

# LAB GIN 2000 0.7 L | 700 ml

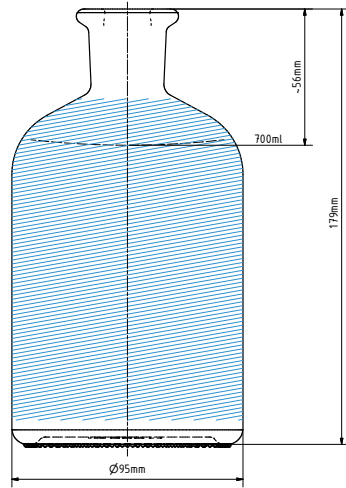

 Area for personalization



## SPECIFICATION

Volume	<b>700 ml</b>
Brimful	<b>766 ml</b>
Weight	<b>500 g</b>
Height	<b>179 mm</b>
Diameter of body	<b>95 mm</b>

## AVERAGE % OF RECYCLED CONTENT

○ Flint	<b>30+</b>	
● Amber	<b>70+</b>	
● Black	<b>75+</b>	

## FINISH TYPE

Bartop	Screw	Bayonete
		
<b>Cork 18.5</b>	—	—
<b>Vinlok 18.5</b>	—	—
<b>Cork 21.5</b>	—	—
<b>Vinlok 21.5</b>	—	—

# LAB GIN 2000 FAT BOY 0.7 L | 700 ml

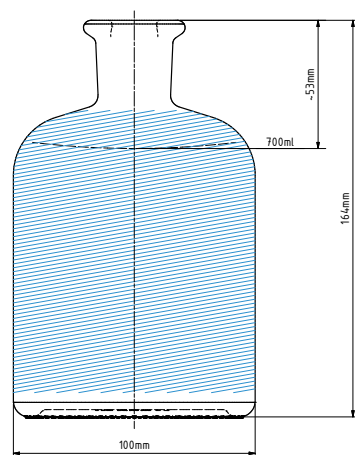

 Area for personalization



## SPECIFICATION

Volume	<b>700 ml</b>
Brimful	<b>766 ml</b>
Weight	<b>500 g</b>
Height	<b>164.5 mm</b>
Diameter of body	<b>100 mm</b>

## AVERAGE % OF RECYCLED CONTENT



## FINISH TYPE

	Bartop	Screw	Bayonete
			
<b>Cork 18.5</b>	—	—	—
<b>Vinolok 18.5</b>	—	—	—
<b>Cork 21.5</b>	—	—	—
<b>Vinolok 21.5</b>	—	—	—

# LAB GIN 2008 0.7 L | 700 ml

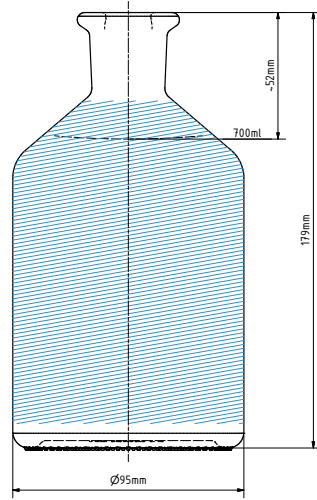



 Area for personalization



## SPECIFICATION

Volume	<b>700 ml</b>
Brimful	<b>737 ml</b>
Weight	<b>500 g</b>
Height	<b>179 mm</b>
Diameter of body	<b>95 mm</b>

## AVERAGE % OF RECYCLED CONTENT

○ Flint	<b>30+</b>	
● Amber	<b>70+</b>	
● Black	<b>75+</b>	

## FINISH TYPE

Bartop	Screw	Bayonete
		
<b>Cork 18.5</b>	—	—
<b>Vinlok 18.5</b>	—	—
<b>Cork 21.5</b>	—	—
<b>Vinlok 21.5</b>	—	—

# MILENIUM 0.7 L | 700 ml

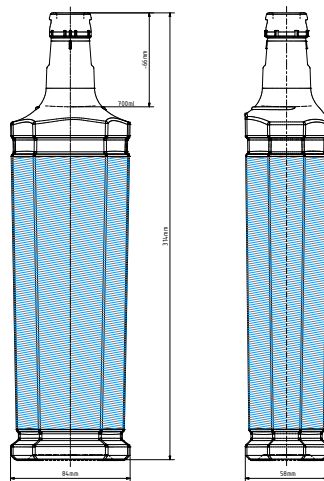

 Area for personalization



## SPECIFICATION

Volume	<b>700 ml</b>
Brimful	<b>728 ml</b>
Weight	<b>625 g</b>
Height	<b>314 mm</b>
Diameter of body (max)	<b>84 × 58 mm</b>

## AVERAGE % OF RECYCLED CONTENT



## FINISH TYPE

Bartop	Screw	Bayonete
		
—	—	<b>Guala 1031/59</b>
—	—	—
—	—	—
—	—	—

# MORAVIA CREAM 0.7 L | 700 ml

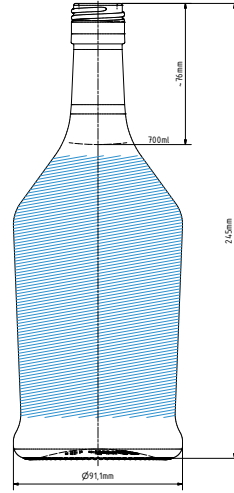







 Area for personalization



## SPECIFICATION

Volume	<b>700 ml</b>
Brimful	<b>728 ml</b>
Weight	<b>580 g</b>
Height	<b>245 mm</b>
Diameter of body (max)	<b>91.1 mm</b>

## AVERAGE % OF RECYCLED CONTENT

 Flint	<b>30+</b>	
 Amber	<b>70+</b>	
 Black	<b>75+</b>	

## FINISH TYPE

Bartop	Screw	Bayonete
		
<b>Cork 18.5</b>	<b>UNI 9574-30</b>	—
<b>Vinolok 18.5</b>	—	—
—	—	—
—	—	—

# MORELLA 0.7 L | 700 ml

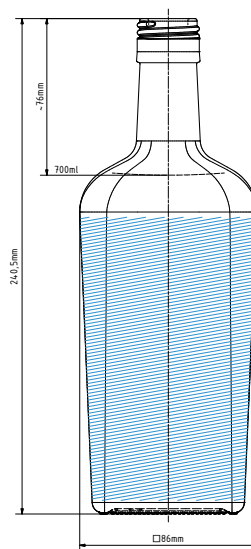

 Area for personalization

## SPECIFICATION

Volume	<b>700 ml</b>
Brimful	<b>740 ml</b>
Weight	<b>730 g</b>
Height	<b>240.5 mm</b>
Diameter of body (max)	<b>86 × 86 mm</b>

## AVERAGE % OF RECYCLED CONTENT



## FINISH TYPE

Bartop	Screw	Bayonete
		
—	<b>PP 31.5 D</b>	—
—	—	—
—	—	—
—	—	—

# REKO 0.7 L | 700 ml

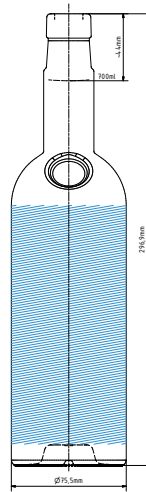

 Area for personalization



## SPECIFICATION

Volume	<b>700 ml</b>
Brimful	<b>720 ml</b>
Weight	<b>520 g</b>
Height	<b>298 mm</b>
Diameter of body (max)	<b>75.5 mm</b>

## AVERAGE % OF RECYCLED CONTENT

○ Flint	<b>30+</b>	
● Amber	<b>70+</b>	
● Black	<b>75+</b>	

## FINISH TYPE

Bartop	Screw	Bayonete
		
<b>Cork 18.5</b>	—	<b>Guala 1031/59</b>
—	—	—
—	—	—
—	—	—



# SAMTREST 0.7 L | 700 ml

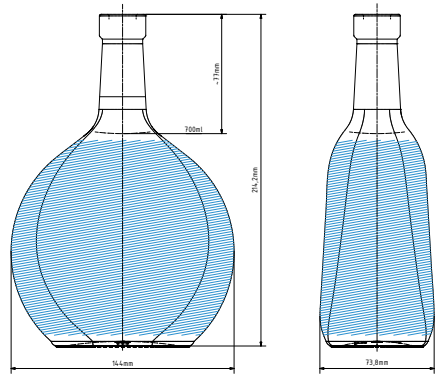

 Area for personalization



## SPECIFICATION

Volume	<b>700 ml</b>
Brimful	<b>720 ml</b>
Weight	<b>580 g</b>
Height	<b>220 mm</b>
Diameter of body (max)	<b>144 × 73.8 mm</b>

## AVERAGE % OF RECYCLED CONTENT



## FINISH TYPE

Bartop	Screw	Bayonete
		
<b>Cork 17.5</b>	<b>UNI 9574-30</b>	—
<b>Vinolok 18.5</b>	—	—
—	—	—
—	—	—

# VODKA 0.7 L | 700 ml

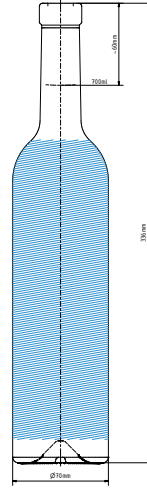

 Area for personalization



## SPECIFICATION

Volume	<b>700 ml</b>
Brimful	<b>717 ml</b>
Weight	<b>550 g</b>
Height	<b>336 mm</b>
Diameter of body (max)	<b>70 mm</b>

## AVERAGE % OF RECYCLED CONTENT

○ Flint	<b>30+</b>	
● Amber	<b>70+</b>	
● Black	<b>75+</b>	

## FINISH TYPE

Bartop	Screw	Bayonete
		
<b>Cork 17.5</b>	<b>PP 31.5</b>	—
<b>Cork 18.5</b>	<b>GPI 400/28</b>	—
<b>Vinlok 18.5</b>	—	—
—	—	—

# VODKA BOTTLE 0.7L | 700 ml

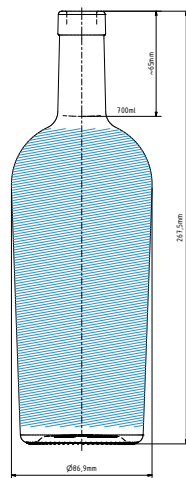

 Area for personalization



## SPECIFICATION

Volume	<b>700 ml</b>
Brimful	<b>724 ml</b>
Weight	<b>750 g</b>
Height	<b>267.5 mm</b>
Diameter of body (max)	<b>86.9 mm</b>

## AVERAGE % OF RECYCLED CONTENT

○ Flint	<b>30+</b>	
● Amber	<b>70+</b>	
● Black	<b>75+</b>	

## FINISH TYPE

Bartop	Screw	Bayonete
		
<b>Cork 18.5</b>	<b>PP 31.5 × 24</b>	—
<b>Vinolok 18.5</b>	<b>GPI 400/28</b>	—
<b>Cork 21.5</b>	—	—
<b>Vinolok 21.5</b>	—	—

# VODKA SERPENT 0.7 L | 700 ml

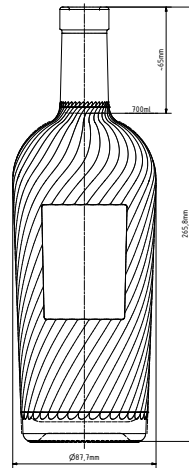

 Area for personalization



## SPECIFICATION

Volume	<b>700 ml</b>
Brimful	<b>725 ml</b>
Weight	<b>750 g</b>
Height	<b>266.4 mm</b>
Diameter of body (max)	<b>87.7 mm</b>

## AVERAGE % OF RECYCLED CONTENT

○ Flint	<b>30+</b>	
● Amber	<b>70+</b>	
● Black	<b>75+</b>	

## FINISH TYPE

Bartop	Screw	Bayonete
		
<b>Cork 18.5</b>	<b>PP 31.5 × 24</b>	—
<b>Vinolok 18.5</b>	<b>GPI 400/28</b>	—
<b>Cork 21.5</b>	—	—
<b>Vinolok 21.5</b>	—	—

# BALATON 0.75 L | 750 ml

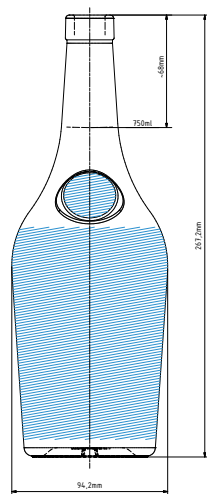

 Area for personalization



## SPECIFICATION

Volume	<b>750 ml</b>
Brimful	<b>776 ml</b>
Weight	<b>620 g</b>
Height	<b>273.5 mm</b>
Diameter of body (max)	<b>94.2 mm</b>

## AVERAGE % OF RECYCLED CONTENT



## FINISH TYPE

Bartop	Screw	Bayonete
		
<b>Cork 18.4</b>	<b>PP 31.5 × 24</b>	—
—	—	—
—	—	—
—	—	—

# BFS 0.75 L | 750 ml

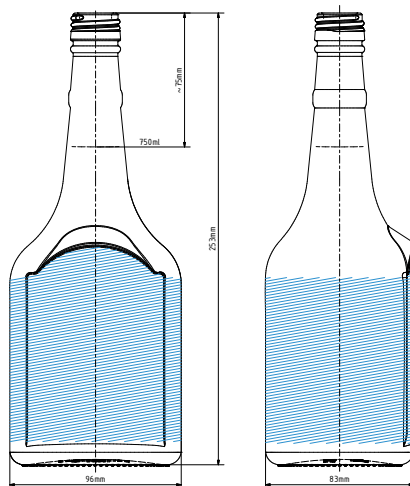

 Area for personalization

## SPECIFICATION

Volume	<b>750 ml</b>
Brimful	<b>775 ml</b>
Weight	<b>610 g</b>
Height	<b>253 mm</b>
Diameter of body (max)	<b>96 × 83 mm</b>

## AVERAGE % OF RECYCLED CONTENT



## FINISH TYPE

Bartop	Screw	Bayonete
		
—	<b>GD-1-28</b>	—
—	—	—
—	—	—
—	—	—

# CREAM LIQUER 0.75 L | 750 ml

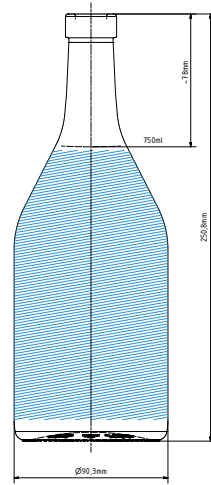

 Area for personalization



## SPECIFICATION

Volume	<b>750 ml</b>
Brimful	<b>783 ml</b>
Weight	<b>570 g</b>
Height	<b>250.8 mm</b>
Diameter of body (max)	<b>90.3 mm</b>

## AVERAGE % OF RECYCLED CONTENT



## FINISH TYPE

Bartop	Screw	Bayonete
		
<b>Cork 18.5</b>	<b>PP 30 × 60</b>	—
<b>Vinolok 18.5</b>	<b>MCA 2</b>	—
—	<b>PP 30 × 60 DZ</b>	—
—	—	—

# LUX BORDELAISE 0.75 L | 750 ml

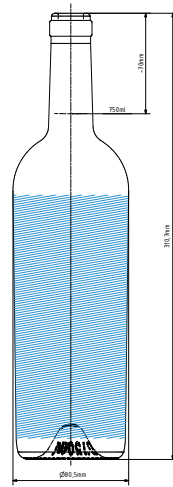

 Area for personalization



## SPECIFICATION

Volume	<b>750 ml</b>
Brimful	<b>770 ml</b>
Weight	<b>750 g</b>
Height	<b>310.7 mm</b>
Diameter of body (max)	<b>80.5 mm</b>

## AVERAGE % OF RECYCLED CONTENT

 Flint	<b>30+</b>	
 Amber	<b>70+</b>	
 Black	<b>75+</b>	

## FINISH TYPE

Bartop	Screw	Bayonete
		
<b>Cork 17.5</b>	<b>PP 31.5 D</b>	—
<b>Vinolok 18.5</b>	—	—
<b>Vinolok 21.5</b>	—	—
—	—	—



# MARTOFF 0.75 L | 750 ml

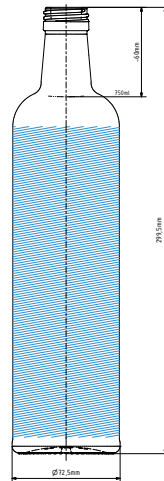

 Area for personalization



## SPECIFICATION

Volume	<b>750 ml</b>
Brimful	<b>774 ml</b>
Weight	<b>550 g</b>
Height	<b>299.5 mm</b>
Diameter of body (max)	<b>72.5 mm</b>

## AVERAGE % OF RECYCLED CONTENT



## FINISH TYPE

Bartop	Screw	Bayonete
		
<b>Cork 18.4</b>	<b>PP 31.5 × 44</b>	—
—	—	—
—	—	—
—	—	—

# TROYANDA 0.75 L | 750 ml

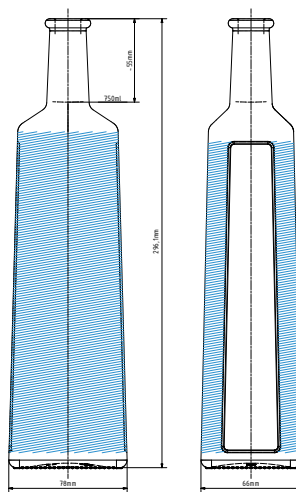



 Area for personalization



## SPECIFICATION

Volume	<b>750 ml</b>
Brimful	<b>770 ml</b>
Weight	<b>640 g</b>
Height	<b>296 mm</b>
Diameter of body (max)	<b>78 × 66 mm</b>

## AVERAGE % OF RECYCLED CONTENT

○ Flint	<b>30+</b>	
● Amber	<b>70+</b>	
● Black	<b>75+</b>	

## FINISH TYPE

Bartop	Screw	Bayonete
		
<b>Cork 17</b>	—	—
—	—	—
—	—	—
—	—	—

# VICE 0.75 L | 750 ml

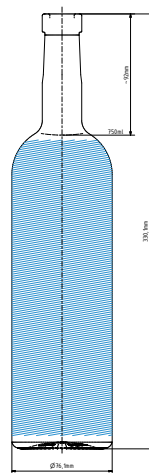

 Area for personalization



## SPECIFICATION

Volume	<b>750 ml</b>
Brimful	<b>790 ml</b>
Weight	<b>800 g</b>
Height	<b>330.1 mm</b>
Diameter of body (max)	<b>76.1 mm</b>

## AVERAGE % OF RECYCLED CONTENT

 Flint	<b>30+</b>	
 Amber	<b>70+</b>	
 Black	<b>75+</b>	

## FINISH TYPE

Bartop	Screw	Bayonete
		
<b>Cork 18.5</b>	<b>GPI 400/33</b>	—
<b>Vinolok 18.5</b>	<b>PP 30 × 60</b>	—
—	—	—
—	—	—

# VINO G 0.75 L | 750 ml

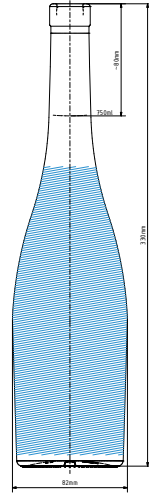



 Area for personalization



## SPECIFICATION

Volume	<b>750 ml</b>
Brimful	<b>770 ml</b>
Weight	<b>570 g</b>
Height	<b>330 mm</b>
Diameter of body (max)	<b>82 mm</b>

## AVERAGE % OF RECYCLED CONTENT

 Flint	<b>30+</b>	
 Amber	<b>70+</b>	
 Black	<b>75+</b>	

## FINISH TYPE

	Bartop	Screw	Bayonete
			
<b>Cork 18.5</b>	—	—	—
<b>Vinlok 18.5</b>	—	—	—
—	—	—	—
—	—	—	—

# VINO SM 0.75 L | 750 ml

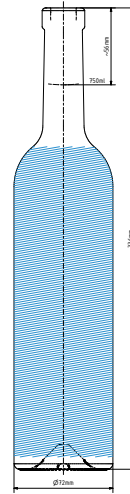

 Area for personalization



## SPECIFICATION

Volume	<b>750 ml</b>
Brimful	<b>767 ml</b>
Weight	<b>560 g</b>
Height	<b>336 mm</b>
Diameter of body (max)	<b>72 mm</b>

## AVERAGE % OF RECYCLED CONTENT

 Flint	<b>30+</b>	
 Amber	<b>70+</b>	
 Black	<b>75+</b>	

## FINISH TYPE

Bartop	Screw	Bayonete
		
<b>Cork 18.5</b>	<b>PP 31.5</b>	—
<b>Vinolok 18.5</b>	—	—
<b>Cork 21.5</b>	—	—
<b>Vinolok 21.5</b>	—	—

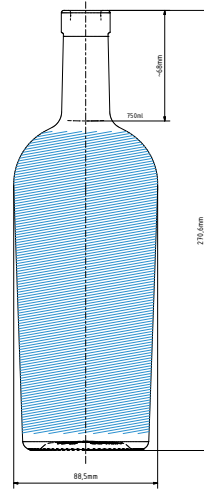

# VODKA BOTTLE 0.75 L | 750 ml



## SPECIFICATION

Volume	<b>750 ml</b>
Brimful	<b>774 ml</b>
Weight	<b>750 g</b>
Height	<b>270.6 mm</b>
Diameter of body (max)	<b>88.5 mm</b>

## FINISH TYPE

Bartop	Screw	Bayonete
		
<b>Cork 18.5</b>	<b>PP 31.5 × 24</b>	—
<b>Vinlok 18.5</b>	<b>GPI 400/28</b>	—
<b>Cork 21.5</b>	—	—
<b>Vinlok 21.5</b>	—	—

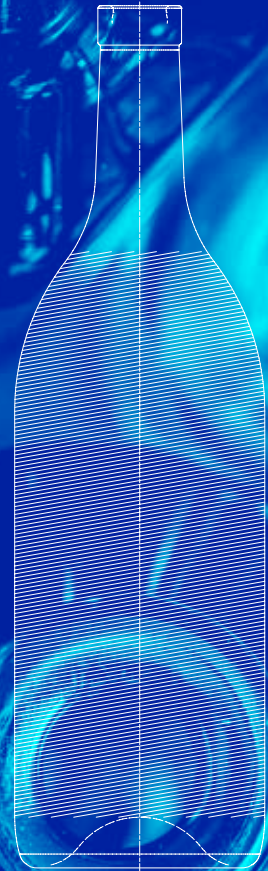

**VOLUME** 1000+ ml

---





# B-LUX 1.0 L | 1000 ml

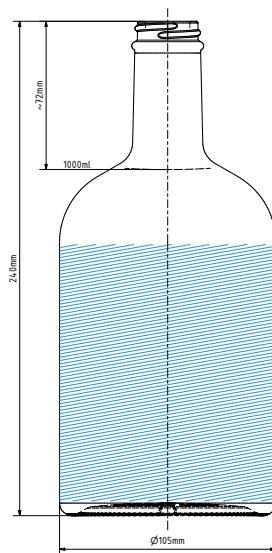

 Area for personalization



## SPECIFICATION

Volume	<b>1000 ml</b>
Brimful	<b>1040 ml</b>
Weight	<b>940 g</b>
Height	<b>240 mm</b>
Diameter of body (max)	<b>105 mm</b>

## AVERAGE % OF RECYCLED CONTENT

<input type="radio"/> Flint	<b>30+</b>	
<input type="radio"/> Amber	<b>70+</b>	
<input type="radio"/> Black	<b>75+</b>	

## FINISH TYPE

Bartop	Screw	Bayonete
		
<b>Cork 21.5</b>	<b>PP 30 × 60</b>	—
<b>Vinolok 21.5</b>	—	—
—	—	—
—	—	—

# CREAM LIQUER 1 L | 1000 ml

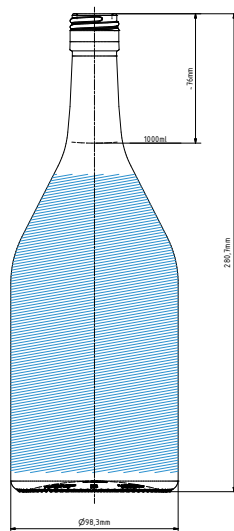



 Area for personalization



## SPECIFICATION

Volume	<b>1000 ml</b>
Brimful	<b>1027 ml</b>
Weight	<b>680 g</b>
Height	<b>280.7 mm</b>
Diameter of body (max)	<b>98.3 mm</b>

## AVERAGE % OF RECYCLED CONTENT

 Flint	<b>30+</b>	
 Amber	<b>70+</b>	
 Black	<b>75+</b>	

## FINISH TYPE

Bartop	Screw	Bayonete
		
<b>Cork 18.5</b>	<b>PP 30 × 60</b>	—
<b>Vinolok 18.5</b>	<b>MCA 2</b>	—
—	<b>PP 30 × 60 DZ</b>	—
—	—	—

# LAB GIN 2000 1.0 L | 1000 ml

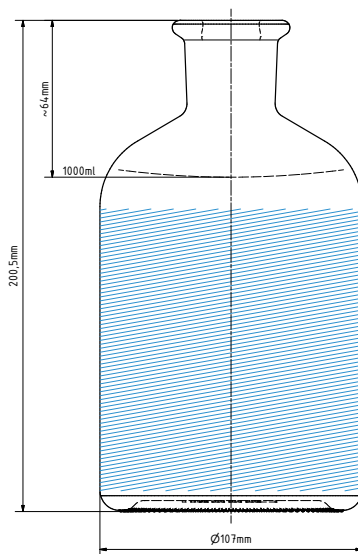

 Area for personalization



## SPECIFICATION

Volume	<b>1000 ml</b>
Brimful	<b>1095 ml</b>
Weight	<b>620 g</b>
Height	<b>200.5 mm</b>
Dimensions of body (max)	<b>107 mm</b>

## AVERAGE % OF RECYCLED CONTENT



## FINISH TYPE

	Bartop	Screw	Bayonete
			
<b>Cork 21.5</b>	—	—	—
<b>Vinolok 21.5</b>	—	—	—
<b>Cork 23</b>	—	—	—
<b>Vinolok 23</b>	—	—	—

# SAGA 1 L | 1000 ml

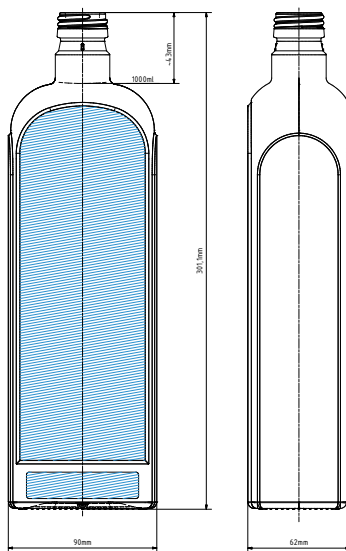

 Area for personalization



## SPECIFICATION

Volume	<b>1000 ml</b>
Brimful	<b>1020 ml</b>
Weight	<b>800 g</b>
Height	<b>301.1 mm</b>
Dimensions of body (max)	<b>90 × 62 mm</b>

## AVERAGE % OF RECYCLED CONTENT

 Flint	<b>30+</b>	
 Amber	<b>70+</b>	
 Black	<b>75+</b>	

## FINISH TYPE

Bartop	Screw	Bayonete
		
<b>Cork 18.5</b>	<b>PP 31.5 × 18</b>	<b>Guala 1031/47</b>
<b>Vinolok 18.5</b>	<b>TO 33</b>	—
—	—	—
—	—	—

# VODKA BOTTLE 1 L | 1000 ml

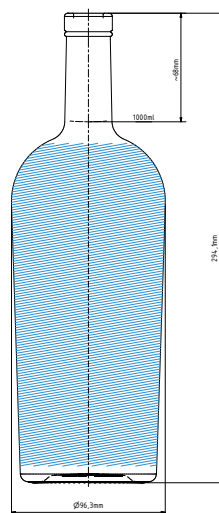

 Area for personalization



## SPECIFICATION

Volume	<b>1000 ml</b>
Brimful	<b>1023 ml</b>
Weight	<b>920 g</b>
Height	<b>294.1 mm</b>
Diameter of body (max)	<b>96.3 mm</b>

## AVERAGE % OF RECYCLED CONTENT

 Flint	<b>30+</b>	
 Amber	<b>70+</b>	
 Black	<b>75+</b>	

## FINISH TYPE

Bartop	Screw	Bayonete
		
<b>Cork 18.5</b>	<b>PP 31.5 × 24</b>	—
<b>Vinolok 18.5</b>	<b>GPI 400/28</b>	—
<b>Cork 21.5</b>	—	—
<b>Vinolok 21.5</b>	—	—

# VODKA SIBERIA 1 L | 1000 ml

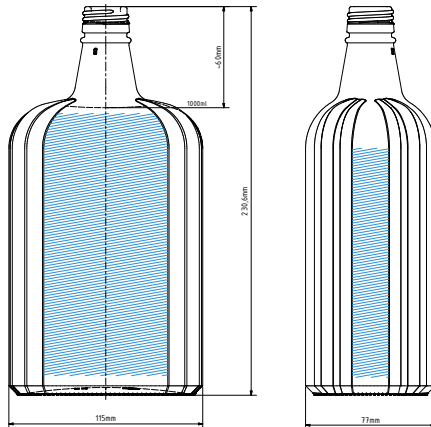

 Area for personalization



## SPECIFICATION

Volume	<b>1000 ml</b>
Brimful	<b>1035 ml</b>
Weight	<b>740 g</b>
Height	<b>230 mm</b>
Dimensions of body (max)	<b>115 × 77 mm</b>

## AVERAGE % OF RECYCLED CONTENT

 Flint	<b>30+</b>	
 Amber	<b>70+</b>	
 Black	<b>75+</b>	

## FINISH TYPE

Bartop	Screw	Bayonete
		
—	<b>PP 28</b>	—
—	—	—
—	—	—
—	—	—

# CREAM LIQUER 1.14 L | 1140 ml

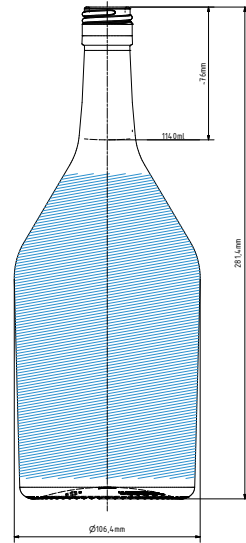

 Area for personalization



## SPECIFICATION

Volume	<b>1140 ml</b>
Brimful	<b>1167 ml</b>
Weight	<b>700 g</b>
Height	<b>281.4 mm</b>
Diameter of body (max)	<b>106.4 mm</b>

## AVERAGE % OF RECYCLED CONTENT



## FINISH TYPE

Bartop	Screw	Bayonete
		
<b>Cork 18.5</b>	<b>PP 30 × 60</b>	—
<b>Vinolok 18.5</b>	<b>MCA 2</b>	—
—	<b>PP 30 × 60 DZ</b>	—
—	—	—

# MAGNUM MORAVIA 1.5 L | 1500 ml

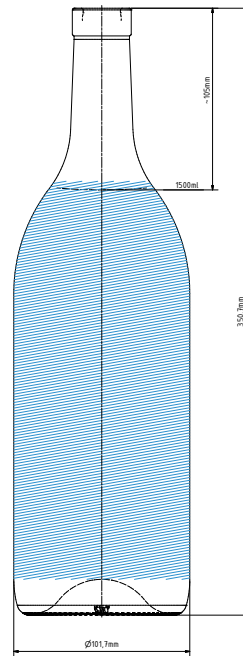

 Area for personalization





## SPECIFICATION

Volume	<b>1500 ml</b>
Brimful	<b>1560 ml</b>
Weight	<b>1000 g</b>
Height	<b>350.7 mm</b>
Diameter of body (max)	<b>101.7 mm</b>

## AVERAGE % OF RECYCLED CONTENT

 Flint	<b>30+</b>	
 Amber	<b>70+</b>	
 Black	<b>75+</b>	

## FINISH TYPE

	Bartop	Screw	Bayonete
			
<b>Vinolok 21.5</b>	—	—	—
—	—	—	—
—	—	—	—
—	—	—	—



# STOCK HANDLE 1.75 L | 1 750 ml

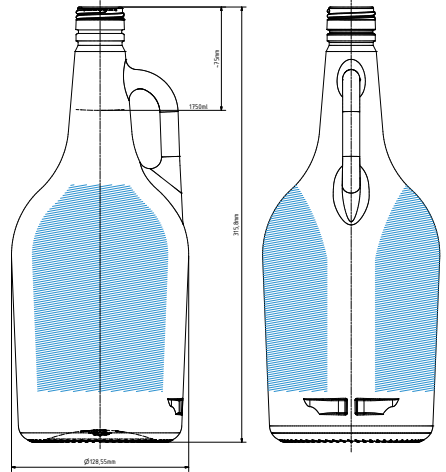

 Area for personalization



## SPECIFICATION

Volume	<b>1750 ml</b>
Brimful	<b>1795 ml</b>
Weight	<b>1310 g</b>
Height	<b>315 mm</b>
Diameter of body (max)	<b>128.5 mm</b>

## AVERAGE % OF RECYCLED CONTENT



## FINISH TYPE

Bartop	Screw	Bayonete
		
—	<b>35 x 24</b>	—
—	—	—
—	—	—
—	—	—



# **APOTHECARY JARS**

---

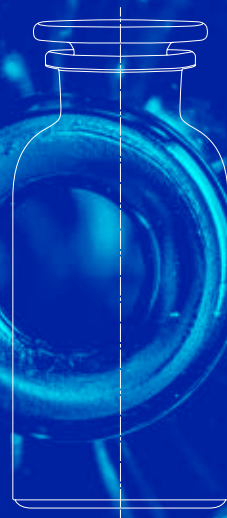



# NARROW NECK REAGENT BOTTLES



## SPECIFICATION

Volume	Weight	Height	Diameter
50 ml	90 g	89 mm	42 mm
100 ml	116 g	109.6 mm	52 mm
250 ml	258 g	143 mm	71 mm
500 ml	430 g	171.4 mm	86 mm
1000 ml	670 g	208.9 mm	107 mm
2000 ml	1080 g	261 mm	135 mm

## STANDARD PACKAGING

Type	Volume (ml)	Pcs in carton	Weight of carton (kg)	Cartons/pallet	Cartons/layer	Layers/pallet	Pcs on pallet	Height/pallet (cm)	Carton size (mm)
2002/50	50	10	1	429	33	13	4290	165	250*100*110
2002/100	100	10	1,5	325	25	13	3250	175	290*118*122
2002/250	250	10	3	176	16	11	1760	185	365*148*145
2002/500	500	10	4,5	80	10	8	800	170	446*180*180
2002/1000	1000	10	7	42	6	7	420	170	605*245*218
2002/2000	2000	6	7	30	6	5	180	155	440*300*267

## TYPE

		
ground	Gr. w/o Stopper	unground
2002/50	2001/50	2000/50
2002/100	2001/100	2000/100
2002/250	2001/250	2000/250
2002/500	2001/500	2000/500
2002/1000	2001/1000	2000/1000
2002/2000	2001/2000	2000/2000



# NARROW NECK STEILBRUST REAGENT BOTTLES



## SPECIFICATION

Volume	Weight	Height	Diameter
50 ml	85 g	88.5 mm	42 mm
100 ml	118 g	109.5 mm	52 mm
250 ml	258 g	143 mm	71 mm
500 ml	460 g	172.4 mm	86 mm
1000 ml	683 g	209.9 mm	107 mm
2000 ml	1113 g	262 mm	135 mm

## TYPE

		
ground	Gr. w/o Stopper	unground
2010/50	2009/50	2008/50
2010/100	2009/100	2008/100
2010/250	2009/250	2008/250
2010/500	2009/500	2008/500
2010/1000	2009/1000	2008/1000
2010/2000	2009/2000	2008/2000

## STANDARD PACKAGING

Type	Volume (ml)	Pcs in carton	Weight of carton (kg)	Cartons/pallet	Cartons/layer	Layers/pallet	Pcs on pallet	Height/pallet (cm)	Carton size (mm)
2010/50	50	10	1	429	33	13	4290	165	250*100*110
2010/100	100	10	1,5	325	25	13	3250	175	290*118*122
2010/250	250	10	3	176	16	11	1760	185	365*148*145
2010/500	500	10	4	80	10	8	800	170	446*180*180
2010/1000	1000	10	7	42	6	7	420	170	605*245*218
2010/2000	2000	6	7	30	6	5	180	155	440*300*267

# WIDE NECK REAGENT BOTTLES





## SPECIFICATION

Volume	Weight	Height	Diameter
50 ml	100 g	88 mm	42.6 mm
100 ml	165 g	106.7 mm	54 mm
250 ml	320 g	142 mm	71 mm
500 ml	540 g	176 mm	87 mm
1000 ml	850 g	199.7 mm	107 mm
2000 ml	1230 g	250 mm	134 mm

## STANDARD PACKAGING

Type	Volume (ml)	Pcs in carton	Weight of carton (kg)	Cartons/pallet	Cartons/layer	Layers/pallet	Pcs on pallet	Height/pallet (cm)	Carton size (mm)
2006/50	50	10	1	429	33	13	4290	165	250*100*110
2006/100	100	10	2	325	25	13	3250	175	290*118*122
2006/250	250	10	3,5	176	16	11	1760	185	365*148*145
2006/500	500	10	6	80	10	8	800	170	446*180*180
2006/1000	1000	10	8,5	42	6	7	420	170	605*245*218
2006/2000	2000	6	7,5	30	6	5	180	155	440*300*267

## TYPE

		
ground	Gr. w/o Stopper	unground
2006/50	2005/50	2004/50
2006/100	2005/100	2004/100
2006/250	2005/250	2004/250
2006/500	2005/500	2004/500
2006/1000	2005/1000	2004/1000
2006/2000	2005/2000	2004/2000



# WIDE NECK RECTANGULAR BOTTLES



## SPECIFICATION

Volume	Weight	Height	Diameter
100 ml	200 g	115 mm	51.1 × 51.1 mm
150 ml	255 g	116.1 mm	70.5 × 51.5 mm
250 ml	312 g	156 mm	70 × 50 mm
350 ml	493 g	165.5 mm	71.5 × 71.5 mm
500 ml	550 g	162.9 mm	92 × 71 mm
750 ml	880 g	246 mm	90 × 70 mm

## TYPE

		
Screw	Gr. w/o Stopper	unground
2043/100	2042/100	2041/100
2043/150	2042/150	2041/150
2043/250	2042/250	2041/250
2043/350	2042/350	2041/350
2043/500	2042/500	2041/500
2043/750	2042/750	2041/750

## STANDARD PACKAGING

Type	Volume (ml)	Pcs in carton	Weight of carton (kg)	Cartons/pallet	Cartons/layer	Layers/pallet	Pcs on pallet	Height/pallet (cm)	Carton size (mm)
2043/100	100	10	2	325	25	13	3250	175	290*118*122
2043/150	150	10	3	176	16	11	1760	185	365*148*145
2043/250	250	10	4	80	10	8	800	170	446*180*180
2043/350	350	10	5	80	10	8	800	170	446*180*180
2043/500	500	10	6	80	10	8	800	170	446*180*180
2043/750	750	15	14	30	6	5	450	155	440*300*267



# DROPPING BOTTLES



## SPECIFICATION

Volume	Weight	Height	Diameter
50 ml	108 g	104 mm	44 mm
100 ml	134 g	119 mm	55 mm

## TYPE

		
ground	Gr. w/o Stopper	unground
2020/50	—	—
2020/100	—	—

## STANDARD PACKAGING

Type	Volume (ml)	Pcs in carton	Weight of carton (kg)	Cartons/pallet	Cartons/layer	Layers/pallet	Pcs on pallet	Height/pallet (cm)	Carton size (mm)
2020/50	50	10	1	429	33	13	4290	165	250*100*110
2020/100	100	10	1,5	325	25	13	3250	175	290*118*122

# BURETTE BOTTLE



## SPECIFICATION

Volume	Weight	Height	Diameter
2000 ml	1140 g	200 mm	160 mm

## TYPE

		
ground	Gr. w/o Stopper	unground
2100/2000	–	–

## STANDARD PACKAGING

Type	Volume (ml)	Pcs in carton	Weight of carton (kg)	Cartons/pallet	Cartons/layer	Layers/pallet	Pcs on pallet	Height/pallet (cm)	Carton size (mm)
2100/2000	2000	6	7	30	5	6	180	150	495*325*210

# WIDE NECK ROUND AND RECTANGULAR BOTTLES WITH SCREW



## SPECIFICATION

Volume	Weight	Height	Diameter
75 ml	90 g	79 mm	48 mm
300 ml	250 g	131.5 mm	69.5 mm
800 ml	480 g	189 mm	89.2 mm
1200 ml	750 g	186 mm	118 mm
250 ml	300 g	145 mm	70 × 50 mm

## TYPE



Screw		
2200/75	—	—
2200/300	—	—
2210/800	—	—
2210/1200	—	—
2250/250	—	—

## STANDARD PACKAGING

Type	Volume (ml)	Pcs in carton	Weight of carton (kg)	Cartons/pallet	Cartons/layer	Layers/pallet	Pcs on pallet	Height/pallet (cm)	Carton size (mm)
2200/75	75	10	1	429	33	13	4290	175	250*100*110
2200/300	300	10	3	176	16	11	1760	185	365*148*145
2210/800	800	10	5	42	6	7	420	170	605*245*218
2210/1200	1200	10	8	42	6	7	420	170	605*245*218
2250/250	250	10	3,5	176	16	11	1760	185	365*148*145





## NOTES

---









# MAKE *the* PERFECT IMPRESSION

Bohemian Bottle brings  
premium packaging to  
a whole new level.

[bohemianbottle.com](http://bohemianbottle.com)



# TRUE ORIGINAL



Bohemian Bottle – a joint adventure formed by four Czech leaders with one aim: to create the best premium packaging for spirits and wines.



## MEET THE TEAM



Bespoken or customized bottles in limited batches.

[sklomoravia.cz](http://sklomoravia.cz)



Turns ordinary bottles into small pieces of luxury inspired by traditional Czech crystal.

[unique-bottle.com](http://unique-bottle.com)



Family owned company with portfolio of various glass decoration services.

[pepper-decor.cz](http://pepper-decor.cz)



Original glass stoppers manufactured with maximum respect for nature.

[vinolok.com](http://vinolok.com)

Premium glass bottles for your  
distinctive exclusive products

---

[www.skloravia.com](http://www.skloravia.com)